



V1504

VERTICAL PLATFORM LIFT

PLANNING GUIDE

Applicable Codes:

ASME A17.1

ASME A18.1

CAN/CSA B355

CAN/CSA B613

Copyright © 2018
Savaria Concord Lifts, Inc.
All rights reserved.

Printed in Canada

Purpose of This Guide

This guide assists architects, contractors, and lift professionals to incorporate the V1504 Vertical Platform Lift into a residential or public building design. The design and manufacture of the V1504 Vertical Platform Lift meets the requirements of the following codes and standards:

- ASME A18.1-2003 Section 2 (Public)
- ASME A18.1-2005 Section 2 (Public)
- ASME A18.1-2008 Section 2 (Public)
- ASME A18.1-2011 Section 2 (Public)
- ASME A18.1-2014 Section 2 (Public)
- ASME A18.1-2017 Section 2 (Public)
- ASME A18.1-2003 Section 5 (Private)
- ASME A18.1-2005 Section 5 (Private)
- ASME A18.1-2008 Section 5 (Private)
- ASME A18.1-2011 Section 5 (Private)
- ASME A18.1-2014 Section 5 (Private)
- ASME A18.1-2017 Section 5 (Private)
- ASME A17.1-1996 Section 20 (Public)
- ASME A17.1-1996 Section 21 (Private)
- CAN/CSA B355 S1-02 (Public)
- CAN/CSA-B355-09 (Public)
- CAN/CSA B613-2000 (Private)

We recommend that you contact your local authority having jurisdiction to ensure that you adhere to all local rules and regulations pertaining to vertical platform lifts.

IMPORTANT: This Planning Guide provides nominal dimensions and specifications useful for the initial planning of a vertical platform lift project. Dimensions and specifications are subject to change without notice due to continually evolving code and product applications.

Before beginning actual construction, please consult Savaria or the authorized Savaria dealer in your area to ensure you receive your site-specific installation drawings with the dimensions and specifications for your project.

Visit our website for the most recent V1504 drawings and dimensions.

How to Use This Guide

- 1 Determine your client's intended use of the lift.
- 2 Determine the local code requirements.
- 3 Determine the site installation parameters.
- 4 Determine the cab type and hoistway size requirements.
- 5 Plan for electrical requirements.

History

April 6, 2010 - Initial release

May 16, 2011 - Updated "Travel speed" in Specifications table to 20 ft/min (0.1 m/s)

June 17, 2011 - Added 24V battery backup to Options to Specifications table on page 5

July 8, 2013 - Added Noise Level to Specifications table on page 4

July 29, 2013 - Added optional 80" cab wall height to Specifications table on page 4

October 7, 2013 - Added seat capacity to Specifications table on page 4

November 12, 2013 - Revised drawings on pages 12 through 26 to include 42"-wide platforms

December 5, 2013 - Revised enclosure drawings on pages 20 through 24

February 12, 2014 - Added seat dimensions on page 27

March 18, 2014 - Revised motor/drive information in Specifications table on page 5

April 7, 2014 - Revised drawings on pages 20-24

April 29, 2014

May 29, 2014 - Added NOTE to page 27 specifying max seat capacity; Changed motor/drive specification on page 4 from 1 HP to 3 HP

June 9, 2014 - Added Remote Controller/Pump Box dimensions on page 28

June 25, 2014 - Added door and gate drawings - pages 25 to 36

July 28, 2014 - Added DuraSwing operator drawings - pages 37 to 40

September 11, 2014 - Removed section "Additional Branch Circuit" from page 43

November 5, 2014 - Revised Applicable Codes on page 3
January 20, 2015 - Added new 2014 code in section above
February 17, 2015 - Revised drawings on pages 13 to 19
September 24, 2015 - Added Daily Cycle to specifications table on page 4
March 1, 2016 - Revised Motor/drive specification in table on page 4
June 3, 2016 - Added spec for Additional Branch Circuit on page 43
July 14, 2016 - Added new Prodoor drawing on page 33
August 8, 2016 - Revised voltage in Standard Features on Specifications table on page 4
February 9, 2017 - Added spec for distance between landings to specs table on page 4
February 16, 2017 - Added spec for temperature to specs table on page 4
April 4, 2017 - Added information for Branch Circuit for Hoistway Pit Lighting and Receptacles to Provisions By Other, Electrical Requirements on page 44
May 29, 2017 - Added NOTE re: centerline to Figure 15 on page 17 and Figure 17 on page 19
August 22, 2017 - Added note re: bracket screws to Site Construction Details on page 6
March 27, 2018 - Revised speed spec on page 4 to say Nominal Speed
September 27, 2018 - Added ASME 18.1-2017 to code list on page 3

Specifications

V1504 Specifications

Specification	Specification Data
Load capacity	750 lb (340 kg)
Seat capacity	330 lb (150 kg)
Maximum travel	23 ft (7 m)
Nominal speed	20 ft/min (0.1 m/s)
Temperature	Indoor: +5 °F to +122 °F (-15 °C to +50 °C) Outdoor: -20 °F to +122 °F (-29 °C to +50 °C)
Noise level (for typical installation)	72.9 dBA (up direction); 50.0 dBA (down direction) Measured at a height of 1m, distance of 1m, in front of the motor with all panels on
Daily cycle	Normal: 30 Heavy: 75 Excessive: 100 Maximum starts in 1 hour on standard installation: 12 NOTE: Please consult your Sales Representative if there a chance you may exceed these amounts.
Levels serviced	2 (standard), 3, 4
Cab sizes	36" x 48" (914 mm x 1219 mm) 36" x 54" (914 mm x 1371 mm) 36" x 60" (914 mm x 1524 mm) 42" x 48" (1067 mm x 1219 mm) 42" x 54" (1067 mm x 1371 mm) 42" x 60" (1067 mm x 1524 mm)
Cab walls (height)	Standard 42-1/8" (1070 mm) Optional 80" (2031 mm)
Cab access	Enter/exit same side (platform Type 1L and 1R) Front/rear access (platform Type 2) 90 degree access (platform Type 3 and 4)
Power supply	120 VAC, 20 A, 60 Hz, single phase
Motor/drive	2:1 chain hydraulic, 3 Hp, gear-type motor (24 VDC)
Control system	Electronic-free relay logic controller
Distance between 2 landings	7" (178 mm) minimum
Tower	Modular 8 ft (2.4 m) base guide rail assembly Roller guide support
Pit depth requirement	3" (76.2 mm)
Finish	Beige electrostatic powder coat paint on all steel surfaces and vacuumed formed plastics
Standard features	24 VDC operation Call/send stations at landings Continuous-pressure type buttons Operating control buttons on platform Automatic battery recharging system (115 VAC) Remote manual lowering device Low-voltage controls Limit switches Handrail Non-skid platform surface No machine room required Emergency stop button

V1504 Specifications

Specification	Specification Data
Safety features	Platform gate Safety underpan Door locks Safety brake Emergency stop buttons Manual lowering and battery lowering system
Options	Platform gate with metal insert and electric strike Top landing gate Upper/lower landing door 80" (2032 mm) Fire-rated, flush-mounted landing entrances Folding seat on platform Telephone on platform Custom color Fixed access ramp Public building package Outdoor package Automatic safety ramp on platform (for outdoor model) 24V battery backup Remote controller/pump box

Site Construction Details

The V1504 needs a wall that supports a minimum of 472 lb (2100 N) of pull out force at any bracket. Note that the brackets come with the proper hardware to secure them in place (1/2" x 3" lag screws for wood/drywall or 1/2" x 4-1/4" anchor wedge screws for concrete walls). The floor must be capable of supporting a load of 3200 lb (14.2 kN). See Figure 1. A wall with a combination of two columns of three 2x4's, or a concrete or brick wall is required.

Figure 2 details a sample wooden support wall configuration

Figure 1: Wall/Floor Loading

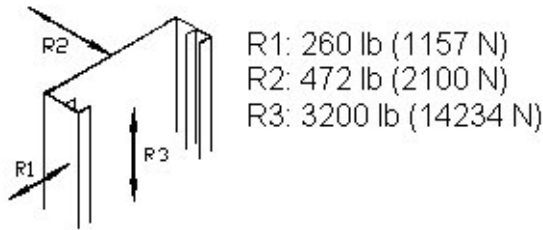

Figure 2: Sample Wooden Support Wall Configuration

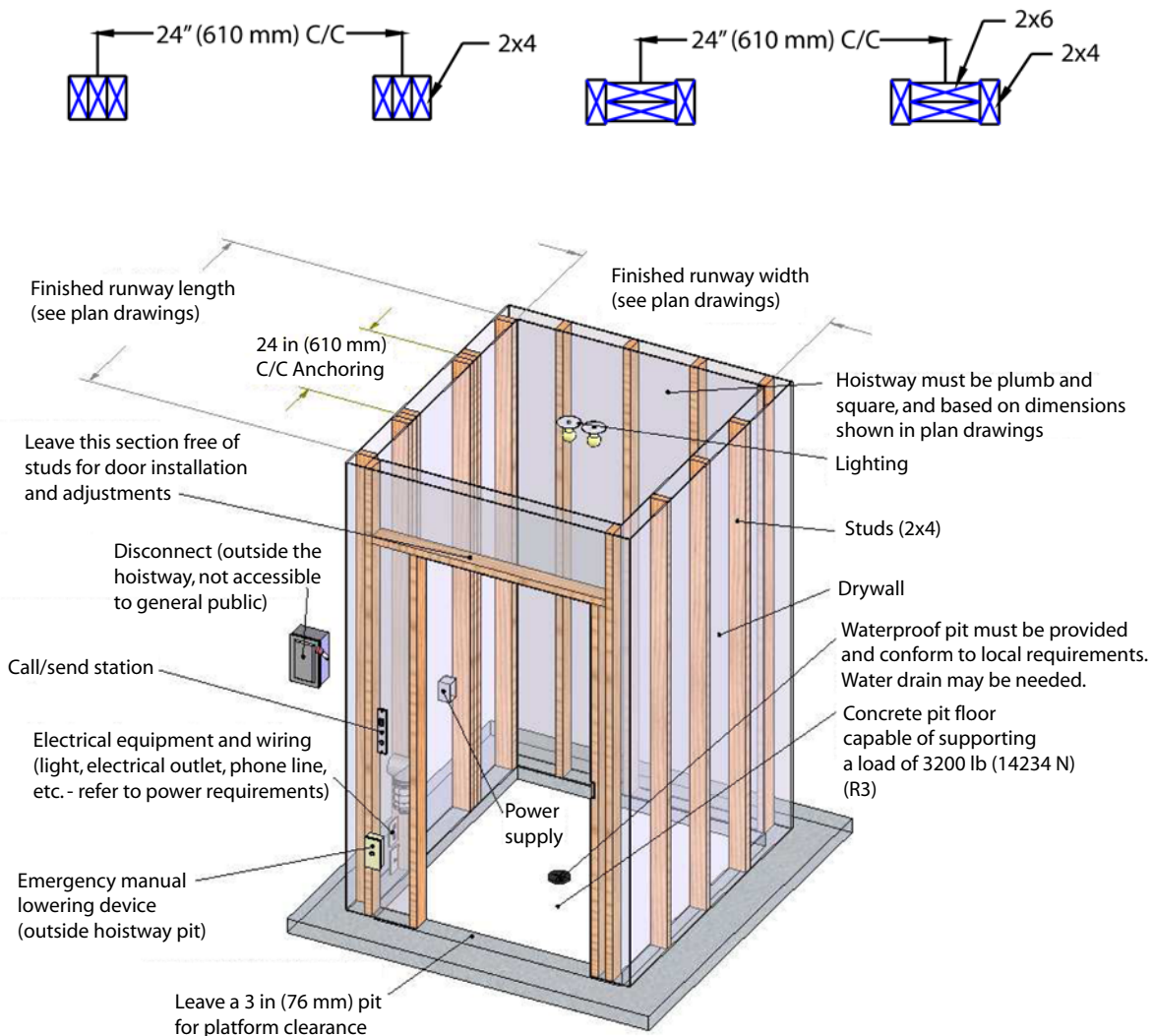

Figure 3 illustrates the recommended steps for constructing a wooden hoistway.

Figure 3: Wooden Hoistway Construction - Recommended Steps

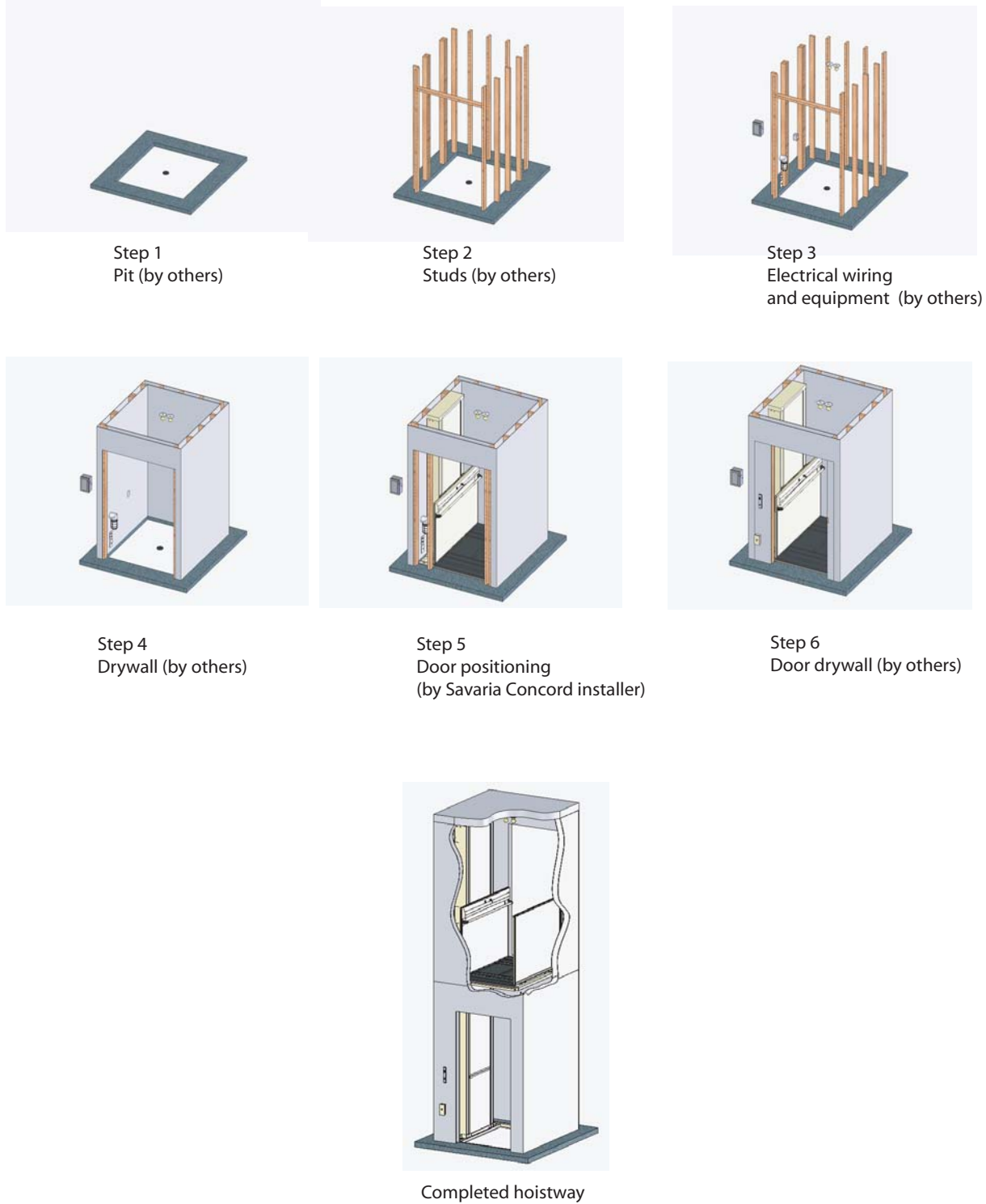

Figure 4 illustrates a sample concrete/steel structure configuration.

Figure 4: Sample Concrete/Steel Structure Configuration

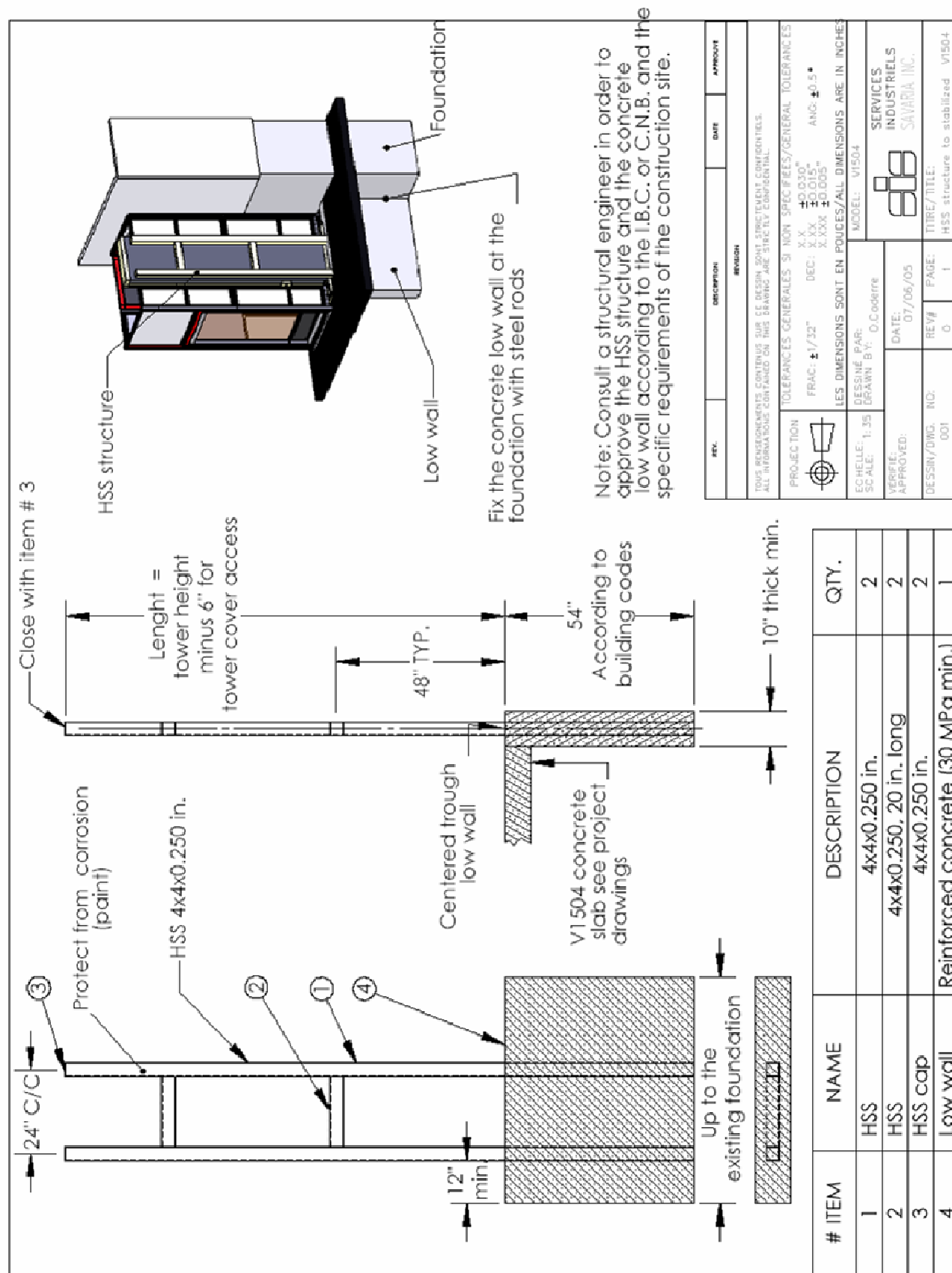

Figure 5 illustrates a sample outdoor enclosure application.

Figure 5: Sample Outdoor Enclosure Application

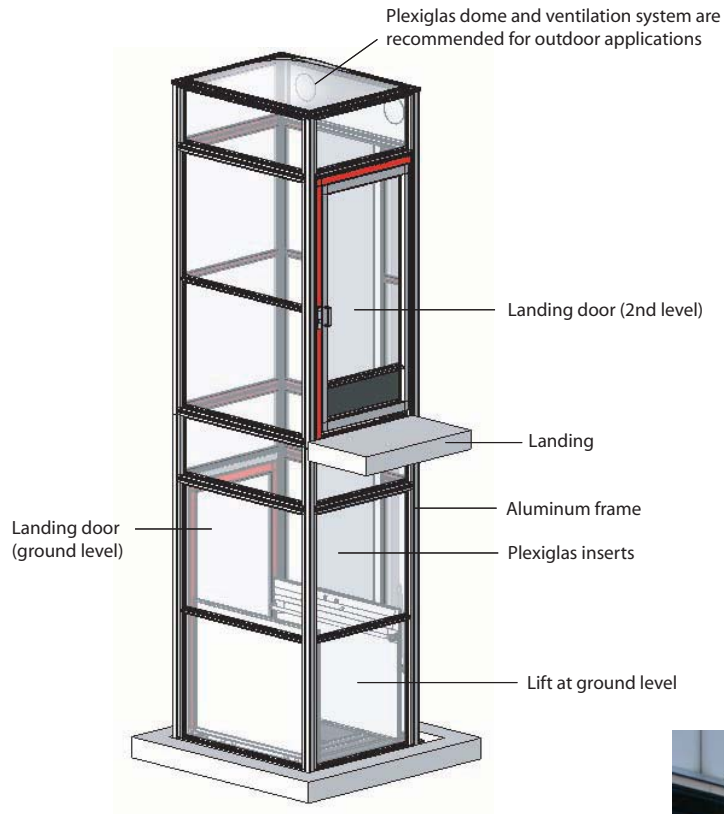

Figure 6 illustrates the site construction details for a typical outdoor application.

Figure 6: Sample Unenclosed Outdoor Application

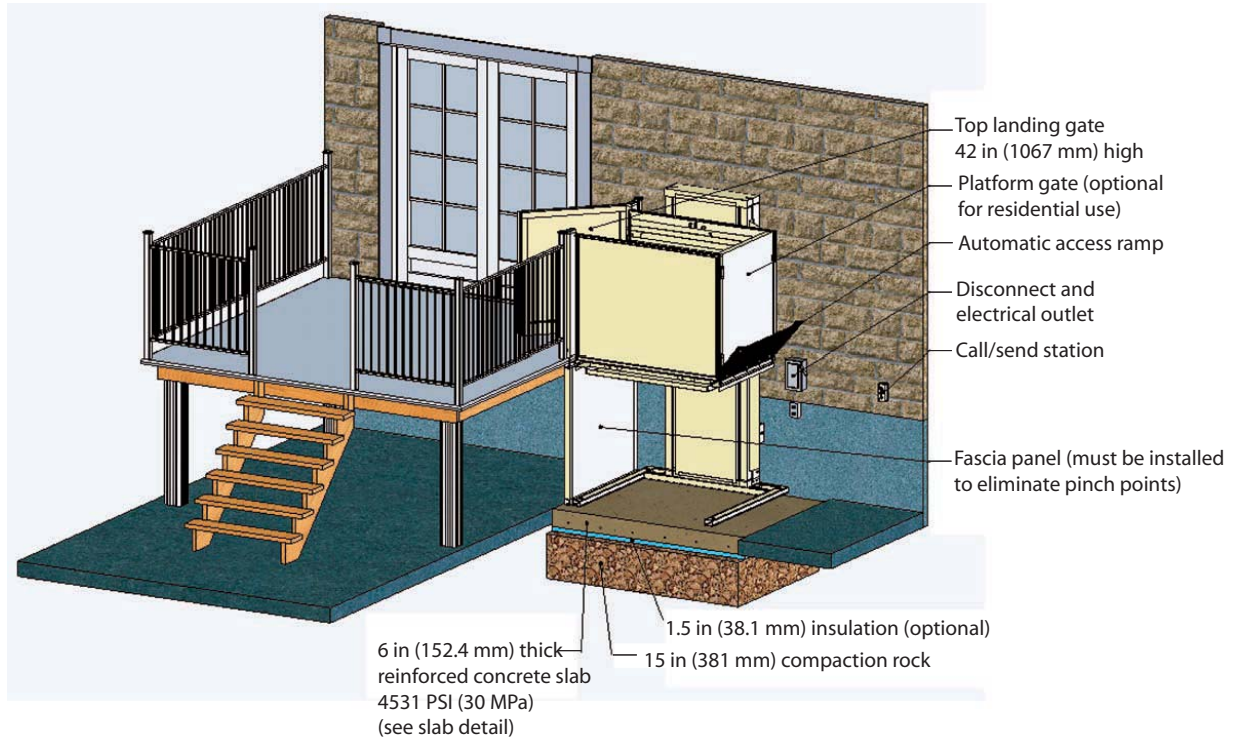
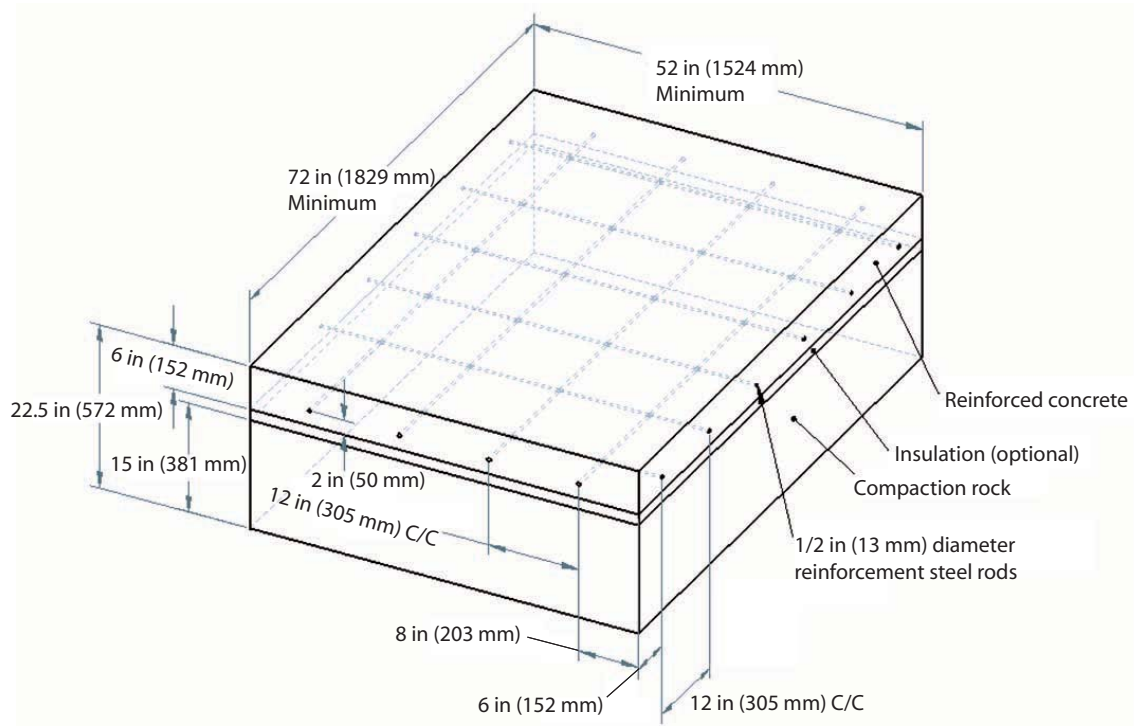

Figure 7 illustrates the concrete slab detail for a typical outdoor application.

Figure 7: Concrete Slab Detail



Cab Types

Type 1 Cabs

For type 1 cabs, entry and exit are available from only one end of the platform.

Figure 8: Type 1 Left and Right

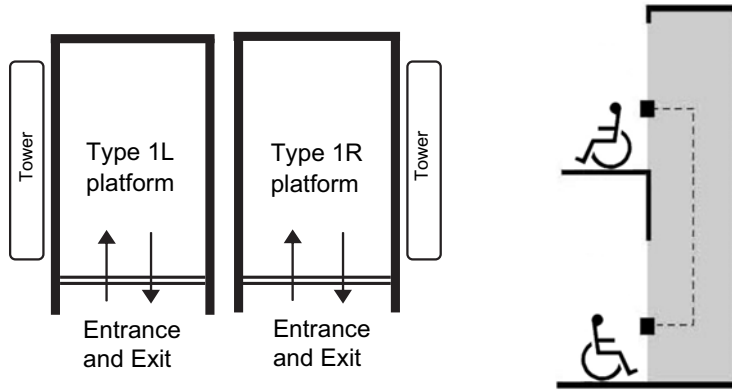

Type 2 Cabs

For type 2 cabs, entry and exit are available from both ends of the platform.

Figure 9: Type 2

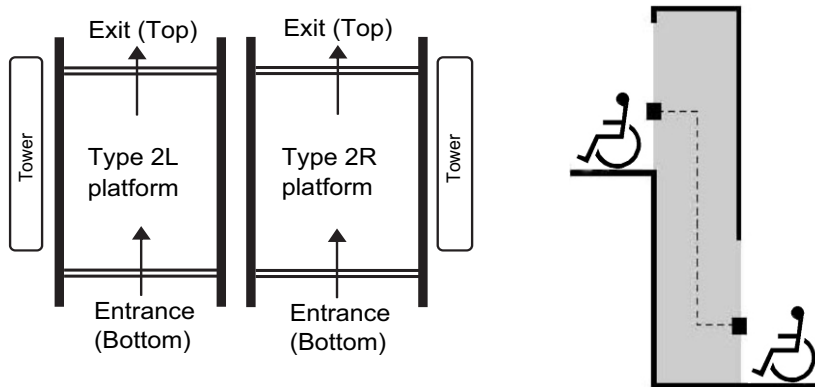

Type 3 and 4 Cabs

For type 3 and 4 cabs, entry and exit are available from one end and one side of the platform.

Figure 10: Type 3 and 4

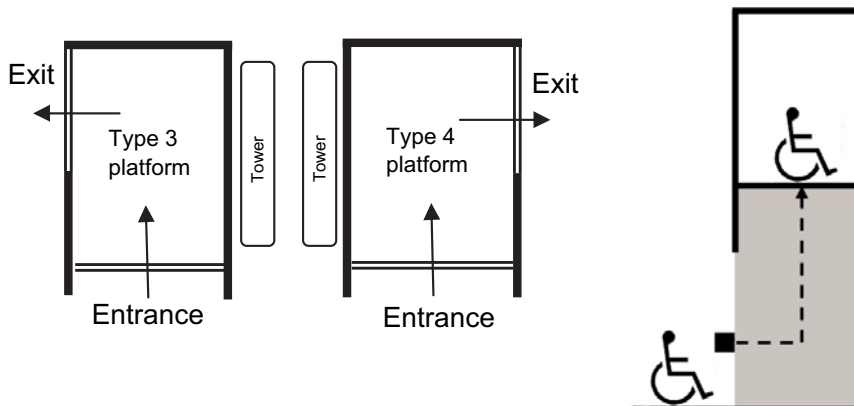

Drawings

- Elevation and plan view, hoistway application (Type 1L)
- Elevation and plan view, hoistway application (Type 1R)
- Elevation and plan view, hoistway application (Type 2)
- Elevation and plan view, hoistway application (Type 3)
- Elevation and plan view, hoistway application (Type 3, 45" opening)
- Elevation and plan view, hoistway application (Type 4)
- Elevation and plan view, hoistway application (Type 4, 45" opening)
- Elevation and plan view, enclosure application (Type 1L)
- Elevation and plan view, enclosure application (Type 1R)
- Elevation and plan view, enclosure application (Type 2)
- Elevation and plan view, enclosure application (Type 3, 45" opening)
- Elevation and plan view, enclosure application (Type 4, 45" opening)
- Auto door, left-hand
- Auto door, right-hand
- Manual door, left-hand
- Manual door, right-hand
- Prodoor auto, left-hand
- Prodoor auto, right-hand
- Prodoor manual, left-hand
- Prodoor manual, right-hand
- Prodoor installation (drywall)
- Auto half gate, left-hand
- Auto half gate, right-hand
- Manual half gate, left-hand
- Manual half gate, right-hand
- DuraSwing on half gate, right-hand
- DuraSwing on half gate, right-hand, 45" opening
- DuraSwing on half gate, left-hand
- DuraSwing on half gate, left-hand, 45" opening
- Seat dimensions
- Remote controller/pump box dimensions

Note: Refer to the Architects & Builders portion of our main website (www.savaria.com) for other door/gate sizes.

Figure 11: Elevation and plan view, hoistway application (Type 1L)

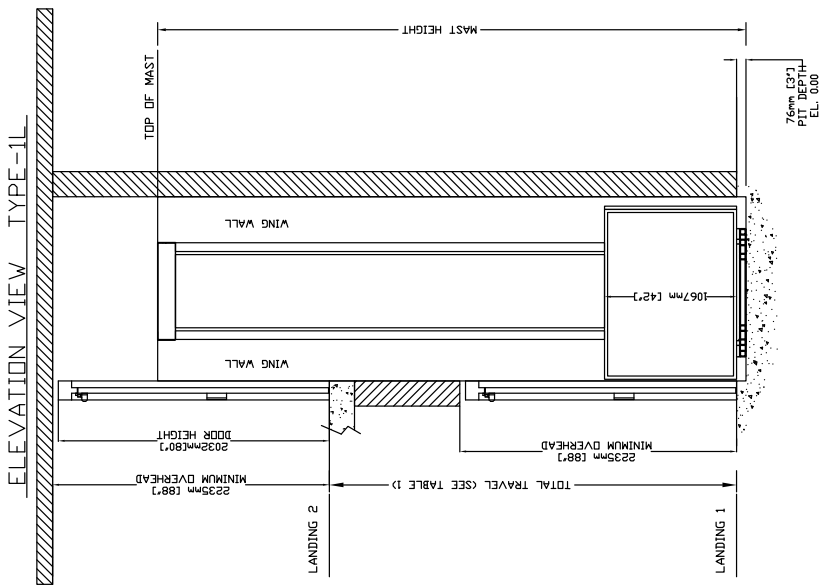

TABLE 1- MAST HEIGHT*

Max. Travel mm (Inches)	Extension Height mm (Inches)		Mast Height with 4.188" CAP	
	mm (Inches)	mm (Inches)	mm (Inches)	mm (Inches)
1219 (48")	1	1778 (70")	1168 (46")	254 (10")
1524 (60")	1	1	1	2748
1829 (72")	1	1	1	3053
2438 (96")	1	1	1	3307
2743 (108")	1	1	1	3916
3048 (120")	1	1	1	4272
3658 (144")	2	1	1	4526
4267 (168")	2	1	1	5136
4877 (192")	2	1	1	6050
5486 (216")	3	1	1	6660
6096 (240")	3	1	1	7269
6706 (264")	3	1	1	7828
7010 (276")	3	1	1	8438
				8692
				342,188

*EXAMPLE TABLE WITH 3' PIT. DIMENSIONS VARY WITH TRAVEL

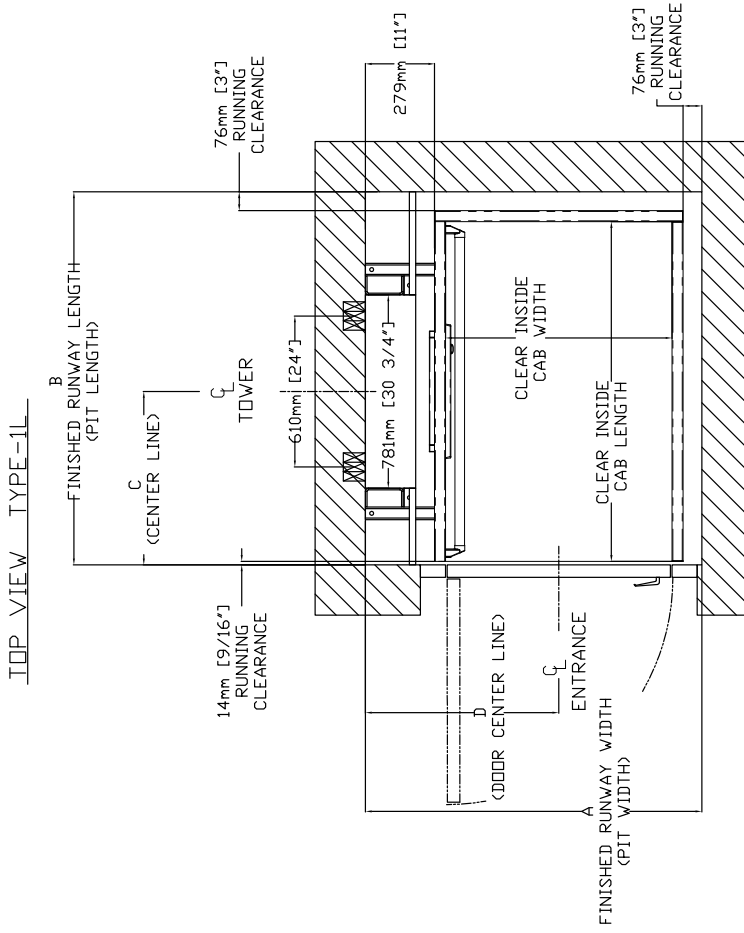

TABLE 2- HOISTWAY DIMENSION

CLEAR INSIDE CAB WIDTH	CLEAR INSIDE CAB LENGTH		FINISHED RUNWAY WIDTH		FINISHED RUNWAY LENGTH		TOWER CENTER LINE		DOOR CENTER LINE (IN CASE OF 36" DOOR)		
	mm	Inches	mm	Inches	mm	Inches	mm	Inches	mm	Inches	
914	36	1219	48	1359	53 1/2	1354	53 5/16	624	24 9/16	781	30 3/4
914	36	1372	54	1359	53 1/2	1507	59 5/16	700	27 9/16	781	30 3/4
914	36	1524	60	1359	53 1/2	1659	65 5/16	776	30 9/16	781	30 3/4
1067	42	1219	48	1511	59 1/2	1354	53 5/16	624	24 9/16	857	33 3/4
1067	42	1372	54	1511	59 1/2	1507	59 5/16	700	27 9/16	857	33 3/4
1067	42	1524	60	1511	59 1/2	1659	65 5/16	776	30 9/16	857	33 3/4

Figure 12: Elevation and plan view, hoistway application (Type 1R)

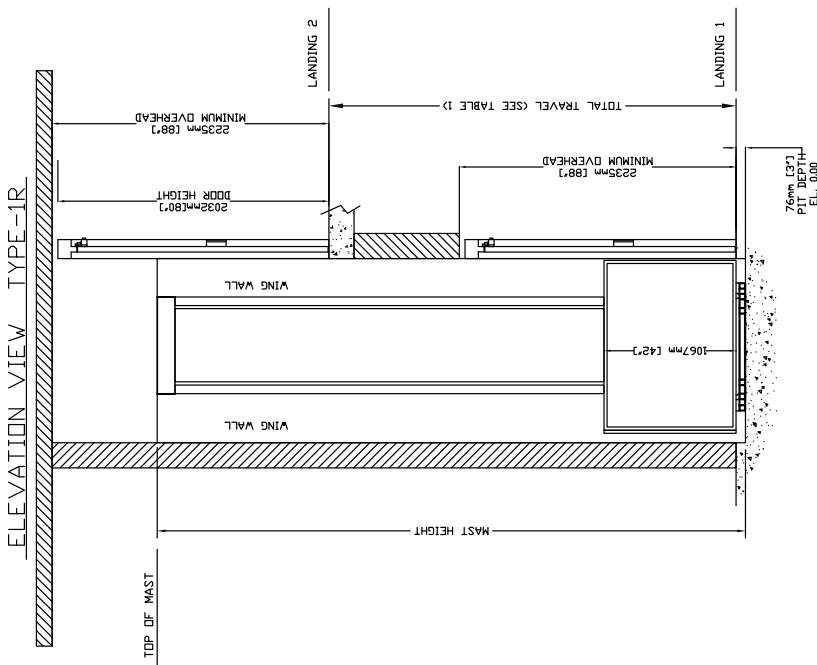

TABLE 1- MAST HEIGHT*

Max. Travel mm (Inches)	Extension Height mm (Inches)	Mast Height with 4.188" CAP mm (Inches)
1219 (48")	1778 (70")	2748 (108.188)
1524 (60")	1168 (46")	3053 (120.188)
1829 (72")	559 (22")	3307 (130.188)
2438 (96")	1	3916 (154.188)
2743 (108")	1	4272 (168.188)
3048 (120")	1	4526 (178.188)
3658 (144")	2	5136 (202.188)
4267 (168")	2	6050 (238.188)
4877 (192")	2	6960 (274.188)
5486 (216")	3	7269 (286.188)
6096 (240")	3	7828 (308.188)
6706 (264")	3	8438 (332.188)
7010 (276")	3	8692 (342.188)

*EXAMPLE TABLE WITH 3" PIT, DIMENSIONS VARY WITH TRAVEL

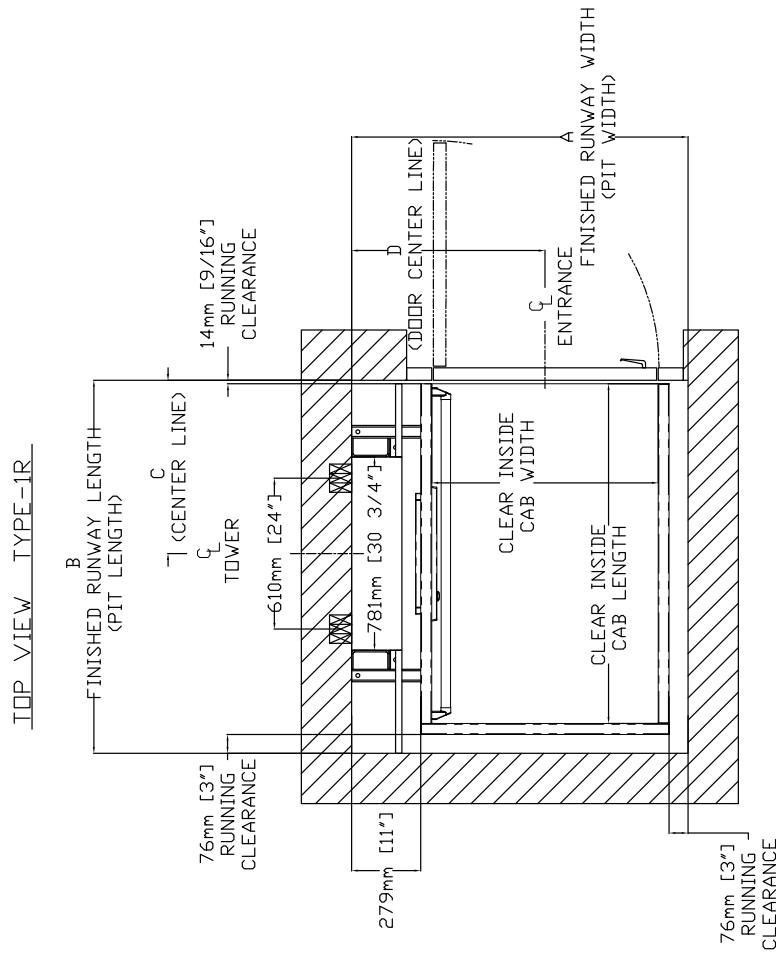

TABLE 2- HOISTWAY DIMENSION

CLEAR INSIDE CAB WIDTH	CLEAR INSIDE CAB LENGTH		FINISHED RUNWAY WIDTH		FINISHED RUNWAY LENGTH		TOWER CENTER LINE		DOOR CENTER LINE (IN CASE OF 36" DOOR)				
	mm	Inches	mm	Inches	mm	Inches	mm	Inches	mm	Inches			
914	36	1219	48	53	1359	53	1354	624	24	9/16	781	30	3/4
914	36	1372	54	59	1359	53	1507	700	27	9/16	781	30	3/4
1067	42	1219	48	53	1524	59	1659	776	30	9/16	857	33	3/4
1067	42	1372	54	59	1511	59	1507	700	27	9/16	857	33	3/4
					1511	59	1659	776	30	9/16	857	33	3/4

Figure 13: Elevation and plan view, hoistway application (Type 2)

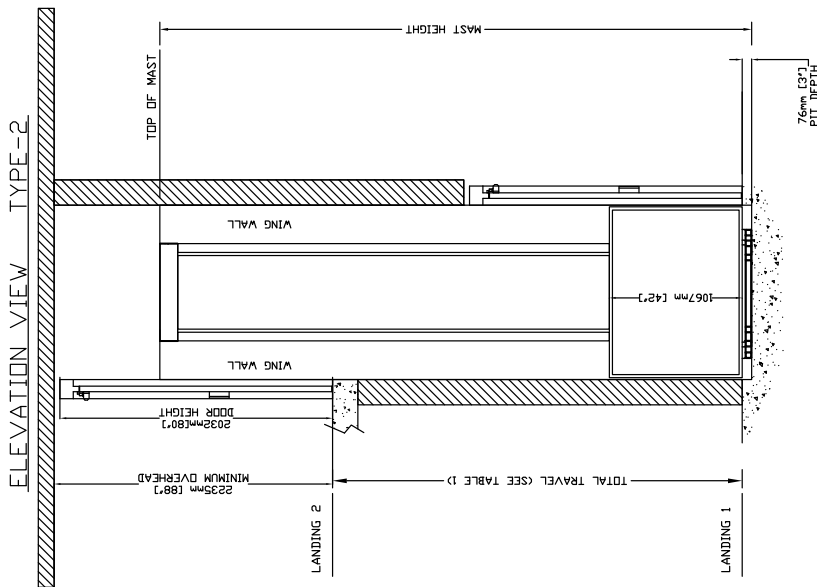

TABLE 1- MAST HEIGHT*

Max. Travel mm (Inches)	Extension Height mm (Inches)	Mast Height with 4,188" CAP mm (Inches)
1219 (48")	1	2748 108.188
1524 (60")	1	3053 120.188
1829 (72")	1	3307 130.188
2438 (96")	1	3916 154.188
2743 (108")	1	4272 168.188
3048 (120")	1	4526 178.188
3658 (144")	2	5136 202.188
4877 (192")	2	6050 238.188
5486 (216")	3	7269 286.188
6096 (240")	3	7828 308.188
6706 (264")	3	8438 332.188
7010 (276")	3	8692 342.188

*EXAMPLE TABLE WITH 3' PIT, DIMENSIONS VARY WITH TRAVEL

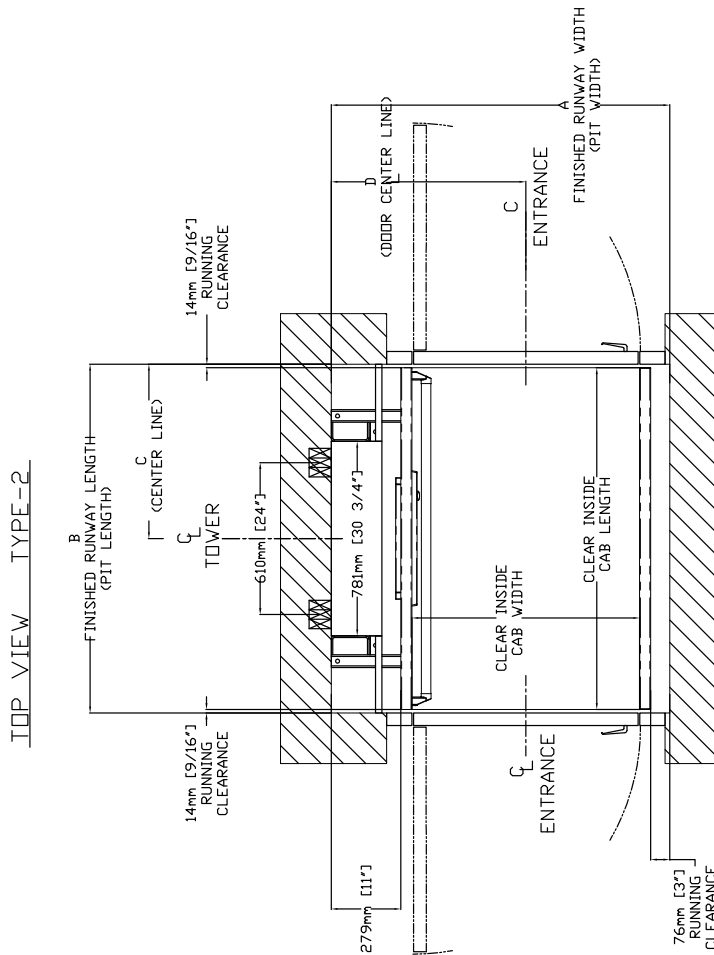

TABLE 2- HOISTWAY DIMENSION

CLEAR INSIDE CAB WIDTH mm	CLEAR INSIDE CAB LENGTH		FINISHED RUNWAY WIDTH		FINISHED RUNWAY LENGTH		TOWER CENTER LINE		DOOR CENTER LINE (IN CASE OF 36" DOOR)	
	mm	Inches	mm	Inches	mm	Inches	mm	Inches	mm	Inches
914	36	1219	48	53 1/2	1359	53 1/8	1248	49 1/8	624	24 9/16
914	36	1372	54	53 1/2	1359	53 1/8	1400	55 1/8	700	27 9/16
914	36	1524	60	53 1/2	1359	53 1/8	1553	61 1/8	776	30 9/16
1067	42	1219	48	59 1/2	1511	59 1/2	1248	49 1/8	624	24 9/16
1067	42	1372	54	59 1/2	1511	59 1/2	1400	55 1/8	700	27 9/16
1067	42	1524	60	59 1/2	1511	59 1/2	1553	61 1/8	776	30 9/16

Figure 14: Elevation and plan view, hoistway application (Type 3)

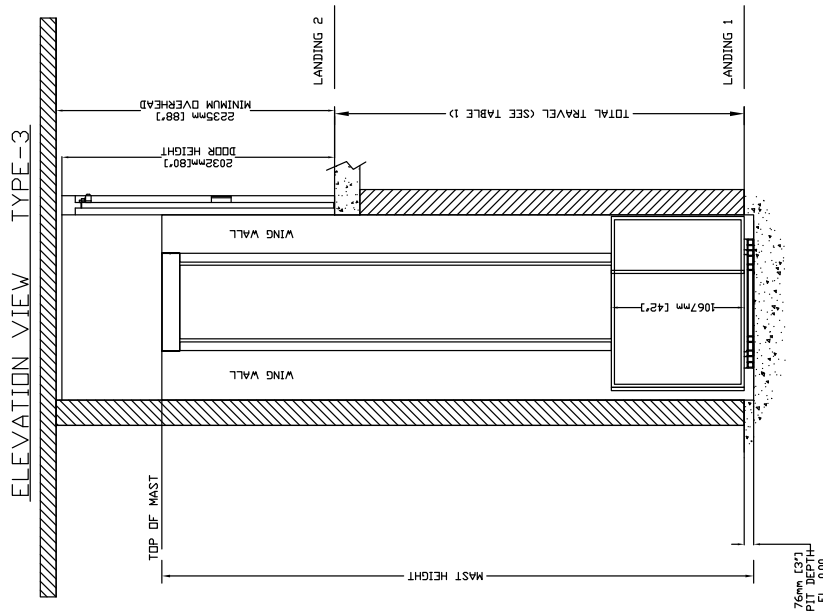

TABLE 1- MAST HEIGHT *

Max. Travel mm (Inches)	Extension Height mm (Inches)		Mast Height with 4,188" CAP mm (Inches)	
	1778 (70")	1168 (46")	559 (22")	254 (10")
1219 (48")	1	1	2748	108,188
1524 (60")	1	1	3053	120,188
1829 (72")	1	1	3307	130,188
2438 (96")	1	1	3916	154,188
2743 (108")	1	1	4272	168,188
3048 (120")	1	1	4526	178,188
3658 (144")	2	1	5136	202,188
4267 (168")	2	1	6050	238,188
4877 (192")	2	1	6660	262,188
5486 (216")	3	1	7269	286,188
6096 (240")	3	1	7828	308,188
6706 (264")	3	1	8438	332,188
7010 (276")	3	1	8692	342,188

*EXAMPLE TABLE WITH 3" PIT. DIMENSIONS VARY WITH TRAVEL

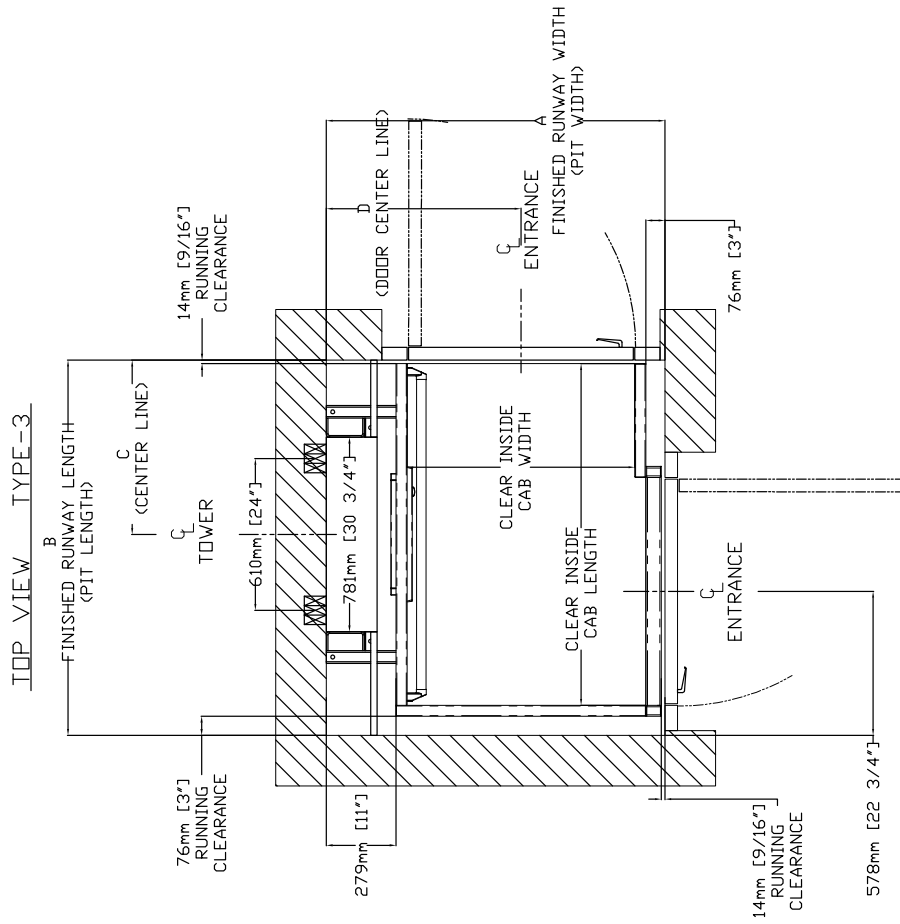

TABLE 2- HOISTWAY DIMENSION

CLEAR INSIDE CAB WIDTH	CLEAR INSIDE CAB LENGTH		FINISHED RUNWAY WIDTH		FINISHED RUNWAY LENGTH		TOWER CENTER LINE	DOOR CENTER LINE (IN CASE OF 36" DOOR)		
	mm	Inches	mm	Inches	mm	Inches				
914	36	1219	48	1354	53 1/2	1354	624	24 9/16	781	30 3/4
914	36	1372	54	1507	63 1/2	1507	700	27 9/16	781	30 3/4
914	36	1524	60	1659	63 1/2	1659	776	30 9/16	781	30 3/4
1067	42	1219	48	1354	53 1/2	1354	624	24 9/16	857	33 3/4
1067	42	1372	54	1507	59 1/2	1507	700	27 9/16	857	33 3/4
1067	42	1524	60	1659	59 1/2	1659	776	30 9/16	857	33 3/4

Figure 15: Elevation and plan view, hoistway application (Type 3, 45" opening)

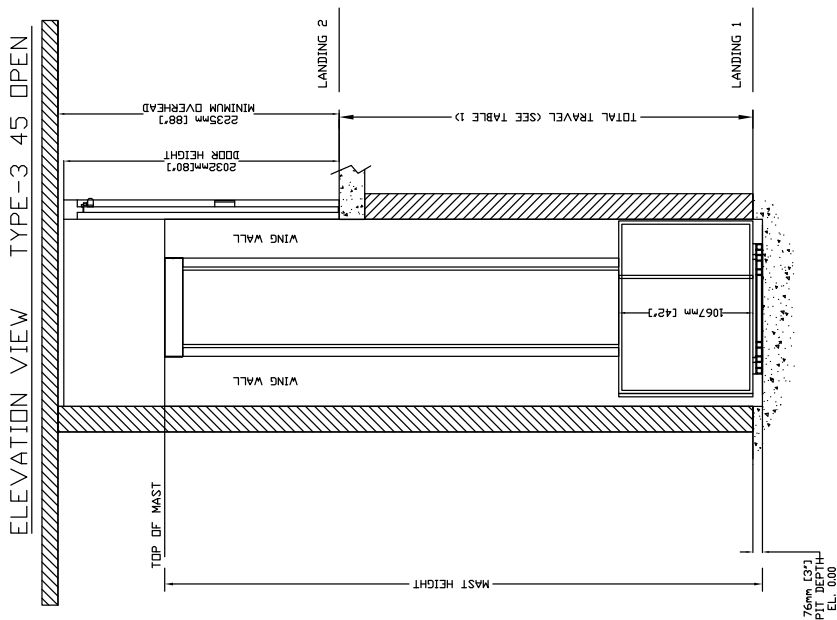
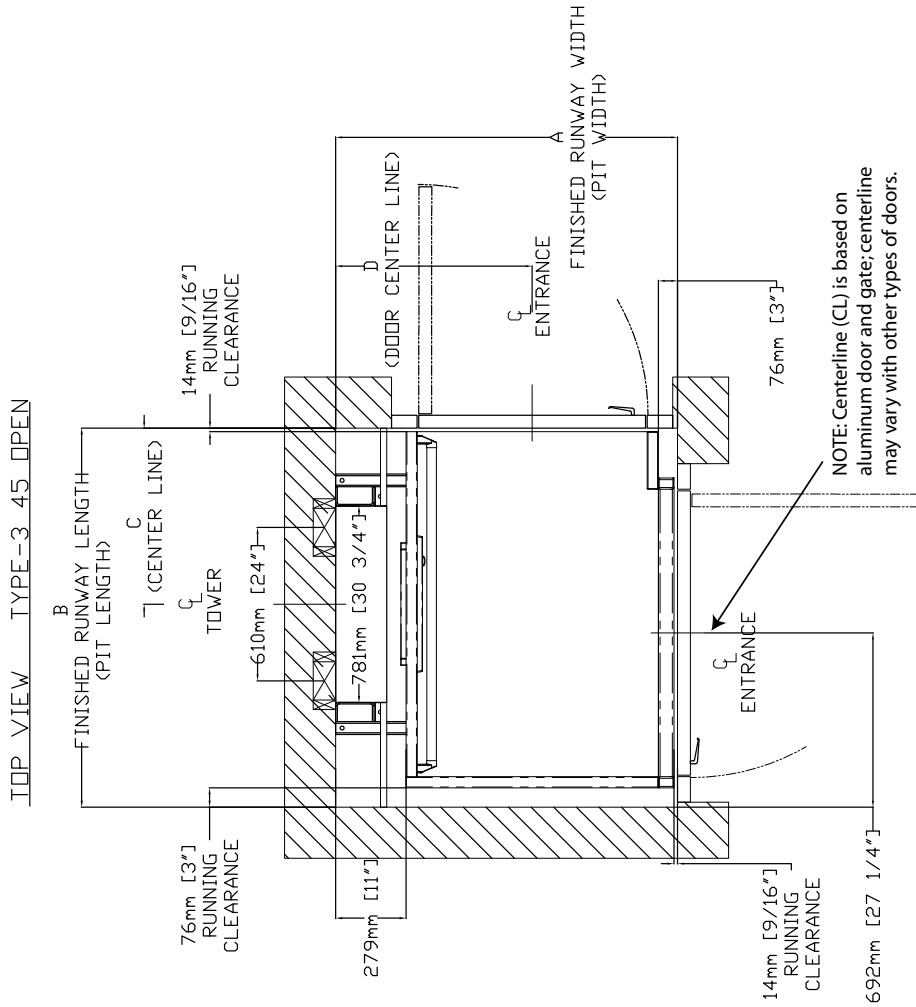

TABLE 1- MAST HEIGHT*

Max. Travel mm (Inches)	Extension Height mm (Inches)		Mast Height with 4.188" CAP mm (Inches)	
	2388 (94")	1778 (70")	1168 (46")	559 (22")
1219 (48")	1	1	2748	108.188
1524 (60")	1	1	3053	120.188
1829 (72")	1	1	3307	130.188
2438 (96")	1	1	3916	154.188
2743 (108")	1	1	4272	168.188
3048 (120")	1	1	4526	178.188
3658 (144")	2	1	5136	202.188
4267 (168")	2	1	6050	238.188
4877 (192")	2	1	6660	262.188
5486 (216")	3	1	7269	286.188
6096 (240")	3	1	7828	308.188
6706 (264")	3	1	8438	332.188
7010 (276")	3	1	8692	342.188

*EXAMPLE TABLE WITH 3" PIT. DIMENSIONS VARY WITH TRAVEL



NOTE: Centerline (CL) is based on aluminum door and gate; centerline may vary with other types of doors.

TABLE 2- HOISTWAY DIMENSION

CLEAR INSIDE CAB WIDTH	CLEAR INSIDE CAB LENGTH		FINISHED RUNWAY WIDTH		FINISHED RUNWAY LENGTH		TOWER CENTER LINE		DOOR CENTER LINE (IN CASE OF 36" DOOR)		
	mm	Inches	mm	Inches	mm	Inches	mm	Inches	mm	Inches	
914	36	1219	48	1359	53 1/2	1354	624	24 9/16	781	30 3/4	
914	36	1372	54	1359	53 1/2	1507	59 5/16	700	27 9/16	781	30 3/4
914	36	1524	60	1359	53 1/2	1659	65 5/16	776	30 9/16	781	30 3/4
1087	42	1219	48	1511	59 1/2	1354	53 5/16	524	24 9/16	857	33 3/4
1087	42	1372	54	1511	59 1/2	1507	59 5/16	700	27 9/16	857	33 3/4
1087	42	1524	60	1511	59 1/2	1659	65 5/16	776	30 9/16	857	33 3/4

Figure 17: Elevation and plan view, hoistway application (Type 4, 45" opening)

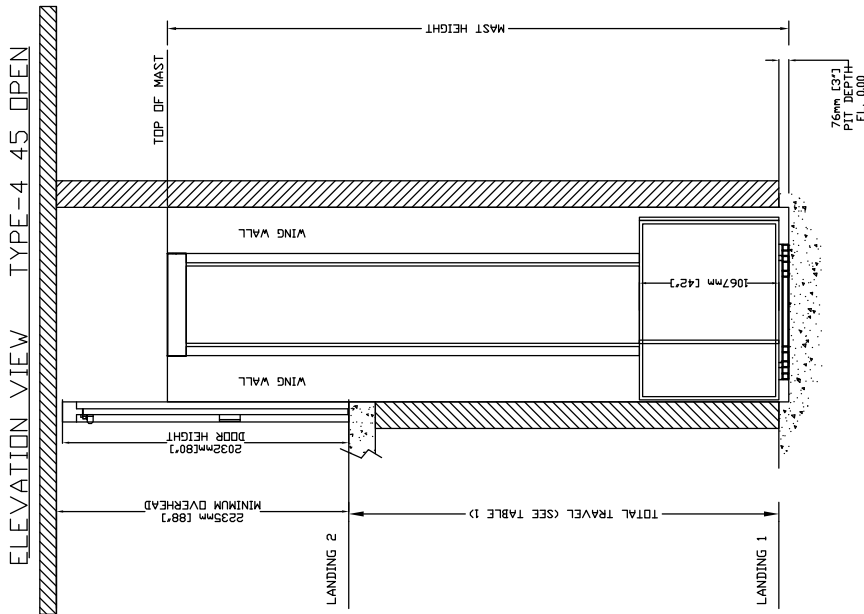
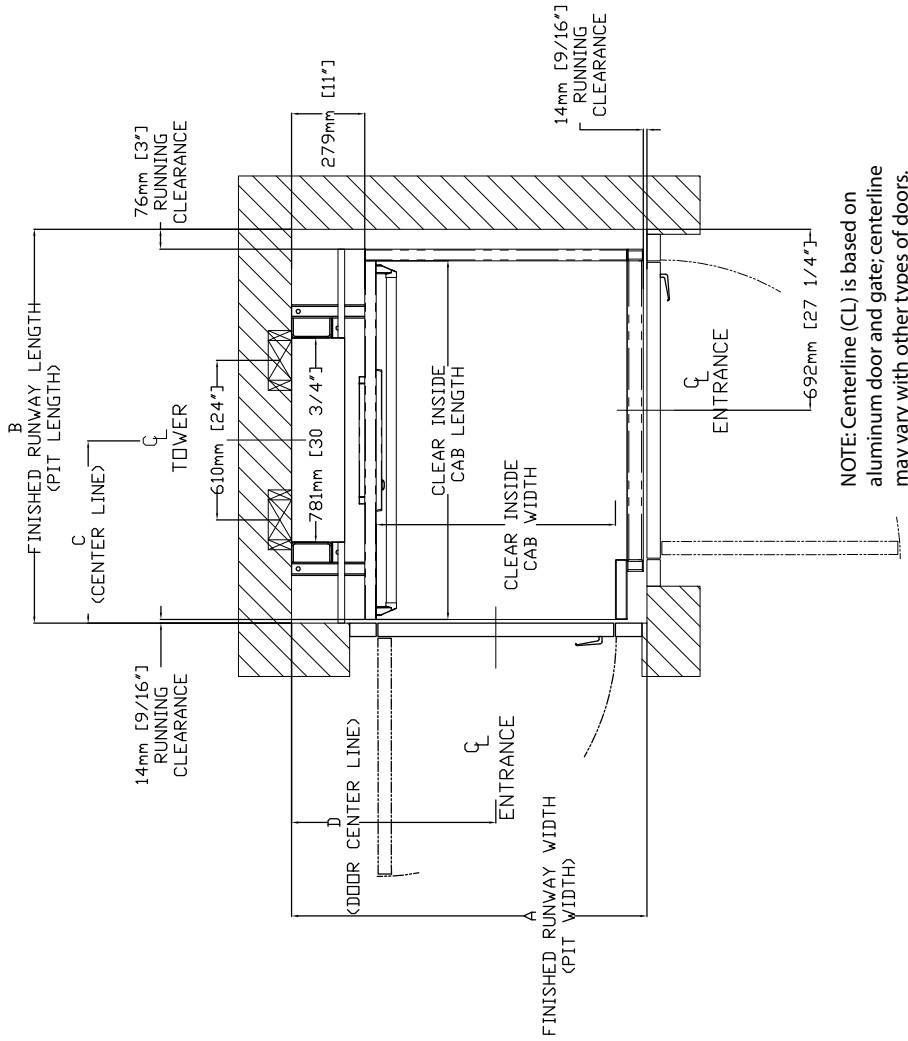

TABLE 1- MAST HEIGHT*

Max. Travel mm (Inches)	Extension Height mm (Inches)	Mast Height with 4.188" CAP mm (Inches)
1219 (48")	2388 (94")	1778 (70")
1524 (60")	1168 (46")	559 (22")
1829 (72")	1	254 (10")
2438 (96")	1	1
2743 (108")	1	1
3048 (120")	1	1
3658 (144")	2	1
4267 (168")	2	1
5486 (216")	3	1
6096 (240")	3	1
6706 (264")	3	1
7010 (276")	3	1

*EXAMPLE TABLE WITH 3" PIT, DIMENSIONS VARY WITH TRAVEL

TOP VIEW TYPE-4 45 OPEN



NOTE: Centerline (CL) is based on aluminum door and gate; centerline may vary with other types of doors.

TABLE 2- HOISTWAY DIMENSION

CLEAR INSIDE CAB WIDTH		CLEAR INSIDE CAB LENGTH		FINISHED RUNWAY WIDTH		FINISHED RUNWAY LENGTH		TOWER CENTER LINE		DOOR CENTER LINE (IN CASE OF 36" DOOR)	
mm	Inches	mm	Inches	mm	Inches	mm	Inches	mm	Inches	mm	Inches
914	36	1219	48	1359	53 1/2	1354	53 5/16	624	24 9/16	781	30 3/4
914	36	1372	54	1359	53 1/2	1507	59 5/16	700	27 9/16	781	30 3/4
1067	42	1219	48	1511	59 1/2	1659	65 5/16	776	30 9/16	857	33 3/4
1067	42	1372	54	1511	59 1/2	1507	59 5/16	700	27 9/16	857	33 3/4
1067	42	1524	60	1511	59 1/2	1659	65 5/16	776	30 9/16	857	33 3/4

Figure 18: Elevation and plan view, enclosure application (Type 1L)

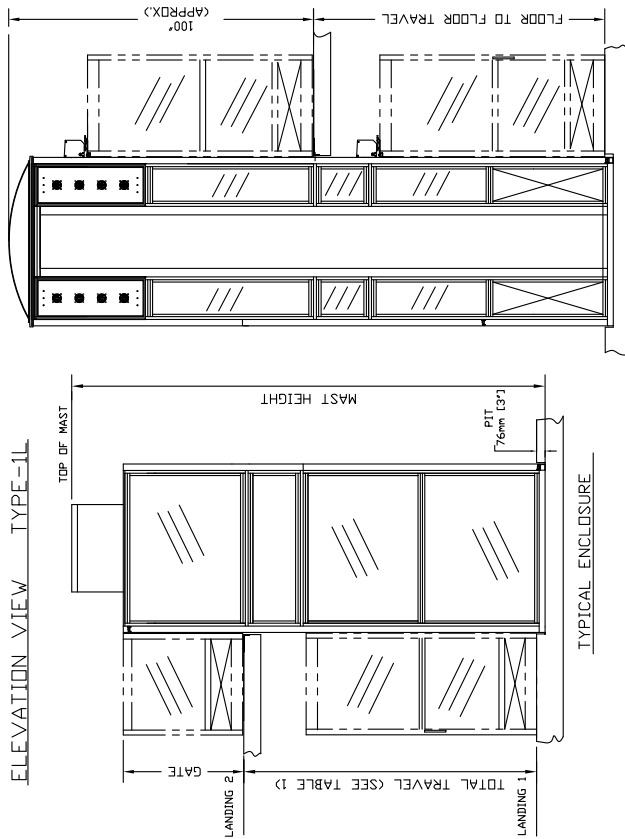
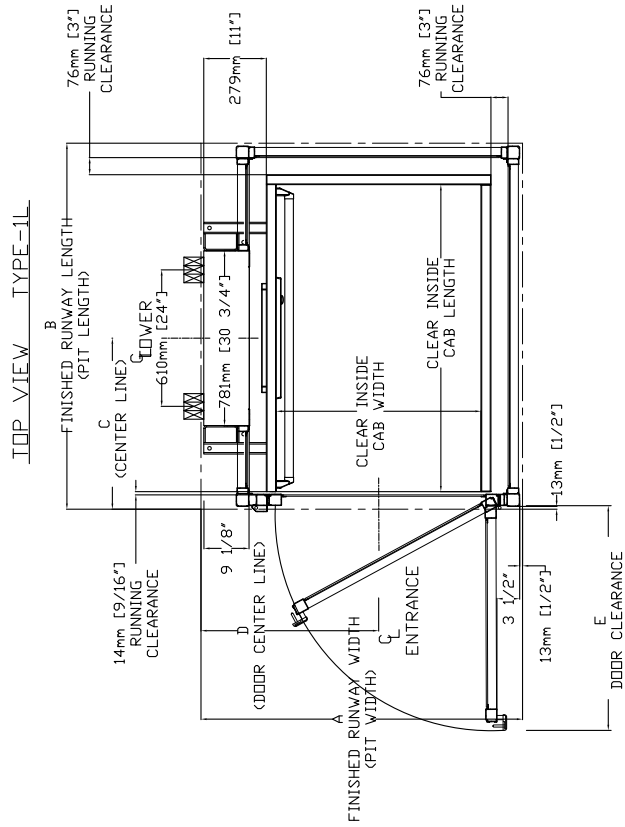

TYPICAL ENCLOSURE WITH EXTENSION & CLEAR PLEXIGLASS DOME & VENTILATION SYSTEM & DOOR OPERATOR

TABLE 1- MAST HEIGHT*

Max. Travel mm (Inches)	Extension Height mm (Inches)		Mast Height Approx with Gate with 4.188" CAP
	mm (Inches)	mm (Inches)	
1219 (48")	2388 (94")	1776 (70")	1168 (46") 559 (22") 264 (10")
1524 (60")	1	1	2748 108 188
1829 (72")	1	1	3053 120 188
2438 (96")	1	1	3662 144 188
2743 (108")	1	1	4272 168 188
3048 (120")	2	1	4882 192 188
3658 (144")	2	1	5440 214 188
4267 (168")	2	1	6050 238 188
4877 (192")	2	1	6660 262 188
5486 (216")	3	1	7269 286 188
6096 (240")	3	1	7828 308 188
6706 (264")	3	1	8438 332 188
7010 (276")	3	1	8692 342 188

*EXAMPLE TABLE WITH 3" PIT, DIMENSIONS VARY WITH TRAVEL

TABLE 2 - ENCLOSURE DIMENSION

CLEAR INSIDE CAB WIDTH	CLEAR INSIDE CAB LENGTH		A		B		C		D		E	
	mm	Inches	mm	Inches	mm	Inches	mm	Inches	mm	Inches	mm	Inches
914	36	1219	48	1437	56	916	1483	58	38	687	27	1116
914	36	1372	54	1437	56	916	1635	64	38	784	30	1116
914	36	1524	60	1437	56	916	1788	70	38	860	33	1116
1067	42	1372	54	1589	62	916	1635	64	38	784	30	1116
1067	42	1524	60	1589	62	916	1788	70	38	840	33	1116

Figure 20: Elevation and plan view, enclosure application (Type 2)

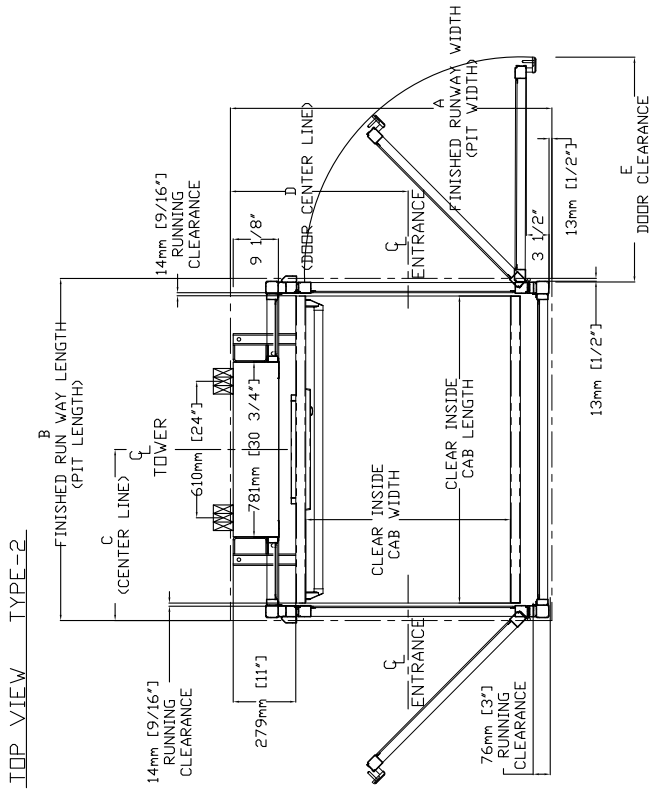

TABLE 2 - ENCLOSURE DIMENSION

CLEAR INSIDE CAB WIDTH	CLEAR INSIDE CAB LENGTH		FINISHED RUNWAY WIDTH		FINISHED RUNWAY LENGTH		TOWER CENTER LINE		DOOR CENTER LINE (IN CASE OF 36" DOOR)		DOOR CLEARANCE								
	mm	Inches	mm	Inches	mm	Inches	mm	Inches	mm	Inches	mm	Inches							
914	36	48	1219	48	1376	54	316	687	27	116	754	31	114	1100	43	5/16			
914	36	54	1437	56	59/16	1376	54	316	687	27	116	754	31	114	1100	43	5/16		
914	36	60	1437	56	59/16	1529	60	316	764	30	118	870	34	114	1253	49	5/16		
914	36	66	1437	56	59/16	1529	60	316	764	30	118	870	34	114	1253	49	5/16		
1067	42	48	1372	54	1589	62	59/16	1529	60	316	764	30	118	870	34	114	1253	49	5/16
1067	42	54	1589	62	59/16	1529	60	316	764	30	118	870	34	114	1253	49	5/16		
1067	42	60	1524	60	1589	62	59/16	1681	66	316	840	33	118	970	34	114	1253	49	5/16

TABLE 1- MAST HEIGHT*

Max Travel mm (Inches)	Extension Height		Mast Height Approx with Gate with 4, 188" CAP				
	mm (Inches)	mm (Inches)	mm (Inches)	Inches			
2388 (94")	1	1778 (70")	1168 (46")	559 (22")	254 (10")	2748	108.188
1219 (48")	1	1	3053	120.188	3053	120.188	
1524 (60")	1	1	3662	144.188	4272	168.188	
1829 (72")	1	1	4272	168.188	4882	192.188	
2134 (84")	1	1	4882	192.188	5440	214.188	
2439 (96")	1	1	5440	214.188	6050	238.188	
2743 (108")	1	1	6050	238.188	6660	262.188	
3048 (120")	1	1	6660	262.188	7269	286.188	
3658 (144")	2	1	7269	286.188	7828	308.188	
4267 (168")	2	1	7828	308.188	8438	332.188	
4877 (192")	2	1	8438	332.188	8692	342.188	
5486 (216")	3	1	8692	342.188			
6096 (240")	3	1					
6706 (264")	3	1					
7010 (276")	3	1					

*EXAMPLE TABLE WITH 3" PIT. DIMENSIONS VARY WITH TRAVEL

Figure 21: Elevation and plan view, enclosure application (Type 3, 45" opening)

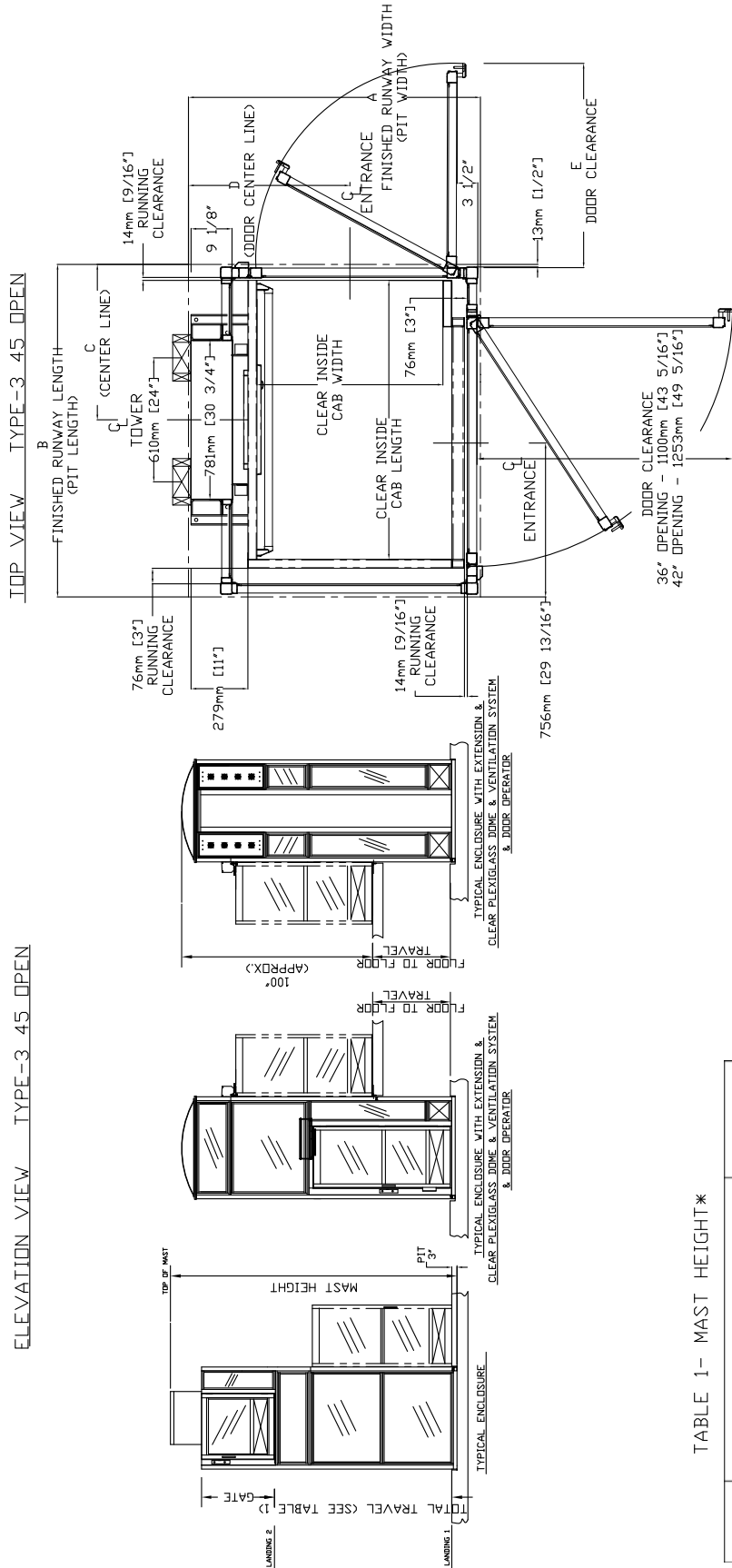

TABLE 2 - ENCLOSURE DIMENSION

CLEAR INSIDE CAB WIDTH	CLEAR INSIDE CAB LENGTH		FINISHED RUNWAY WIDTH		FINISHED RUNWAY LENGTH		TOWER CENTER LINE		DOOR CENTER LINE (IN CASE OF 36" DOOR)		DOOR CLEARANCE	
	mm	Inches	mm	Inches	mm	Inches	mm	Inches	mm	Inches	mm	Inches
914	36	1219	48	1437	56 9/16	1483	58 3/8	687	794	31 1/4	1100	43 5/16
914	36	1372	54	1437	56 9/16	1635	64 3/8	764	794	31 1/4	1100	43 5/16
914	36	1525	60	1437	56 9/16	1833	72 3/8	843	794	31 1/4	1100	43 5/16
1067	42	1372	48	1589	62 9/16	1483	58 3/8	687	870	34 1/4	1253	49 5/16
1067	42	1525	54	1589	62 9/16	1635	64 3/8	764	870	34 1/4	1253	49 5/16
1067	42	1678	60	1589	62 9/16	1788	70 3/8	840	870	34 1/4	1253	49 5/16

TABLE 1 - MAST HEIGHT *

Max Travel mm (Inches)	Extension Height mm (Inches)		Mast Height Approx with Gate with 4.188" CAP
	mm (Inches)	mm (Inches)	
1219 (48")	1	2388 (94")	2748
1524 (60")	1	1778 (70")	3053
1829 (72")	1	1168 (46")	3662
2438 (96")	1	559 (22")	4272
2743 (108")	1	254 (10")	4882
3048 (120")	2		4882
3658 (144")	2		5440
4267 (168")	2		6050
4877 (192")	2		6660
5486 (216")	3		7269
6096 (240")	3		7828
6706 (264")	3		8438
7010 (276")	3		8692

*EXAMPLE TABLE WITH 3" PIT. DIMENSIONS VARY WITH TRAVEL

Figure 23: Auto door, left-hand

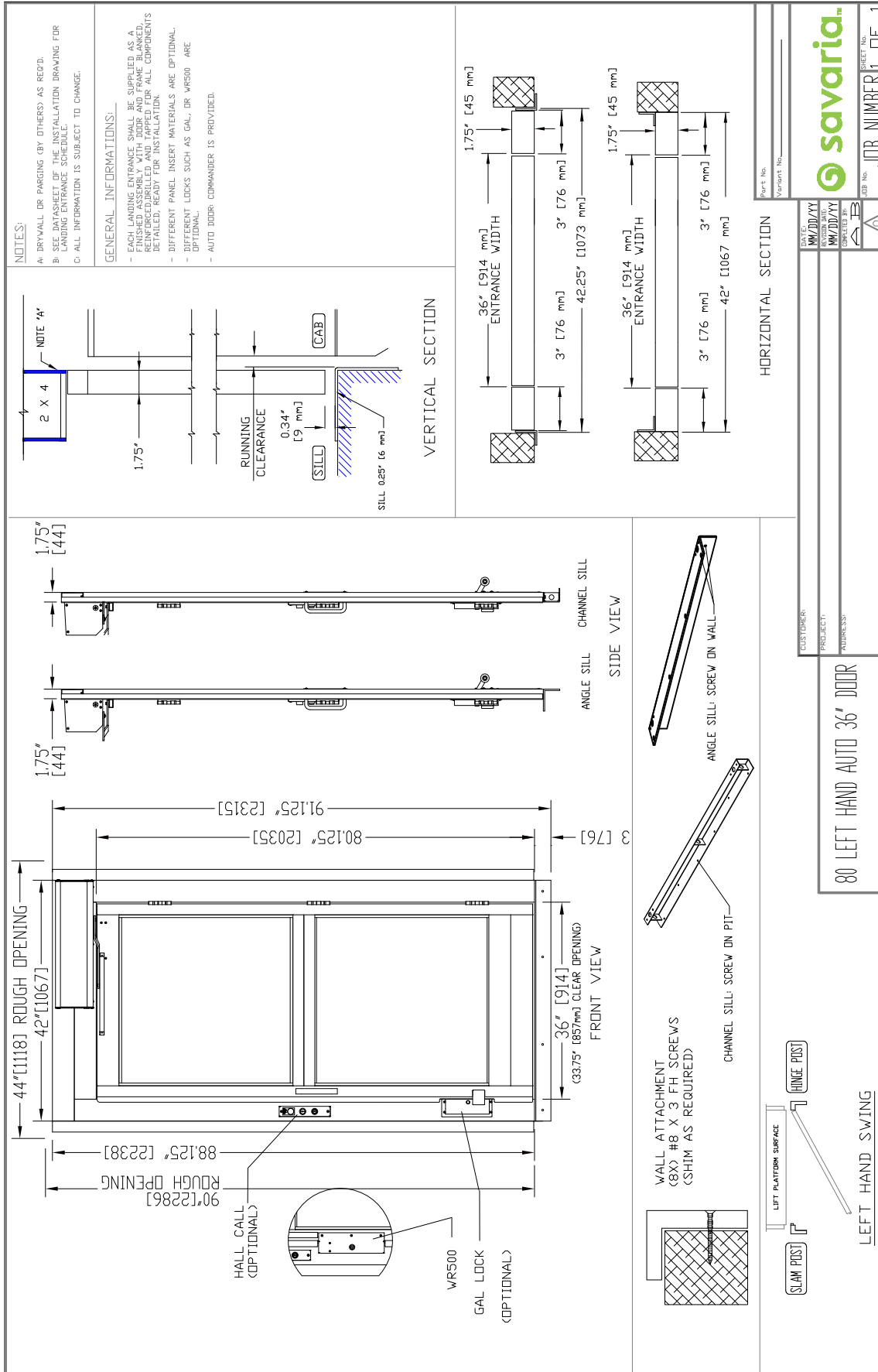

Figure 24: Auto door, right-hand

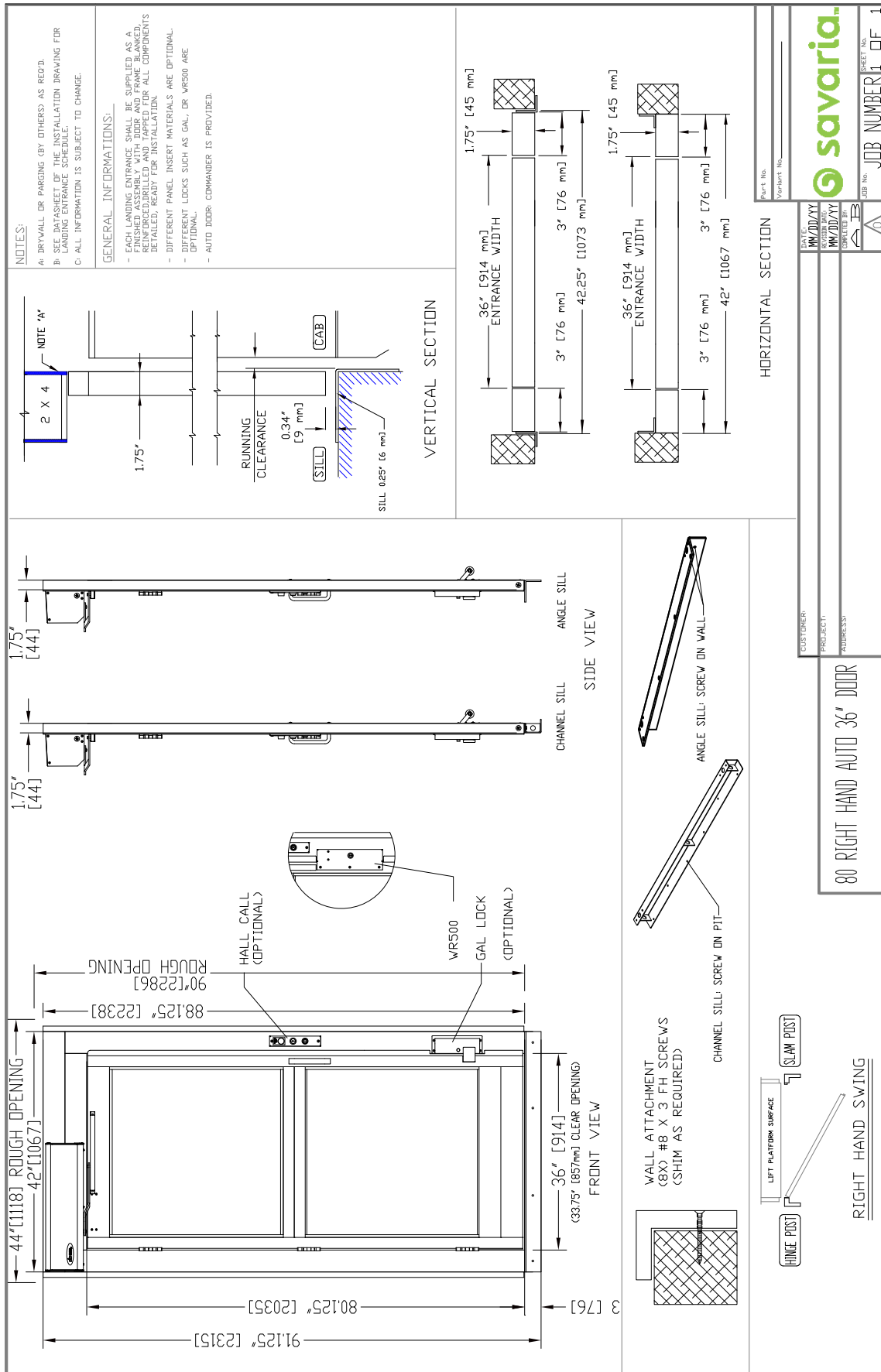

Figure 25: Manual door, left-hand

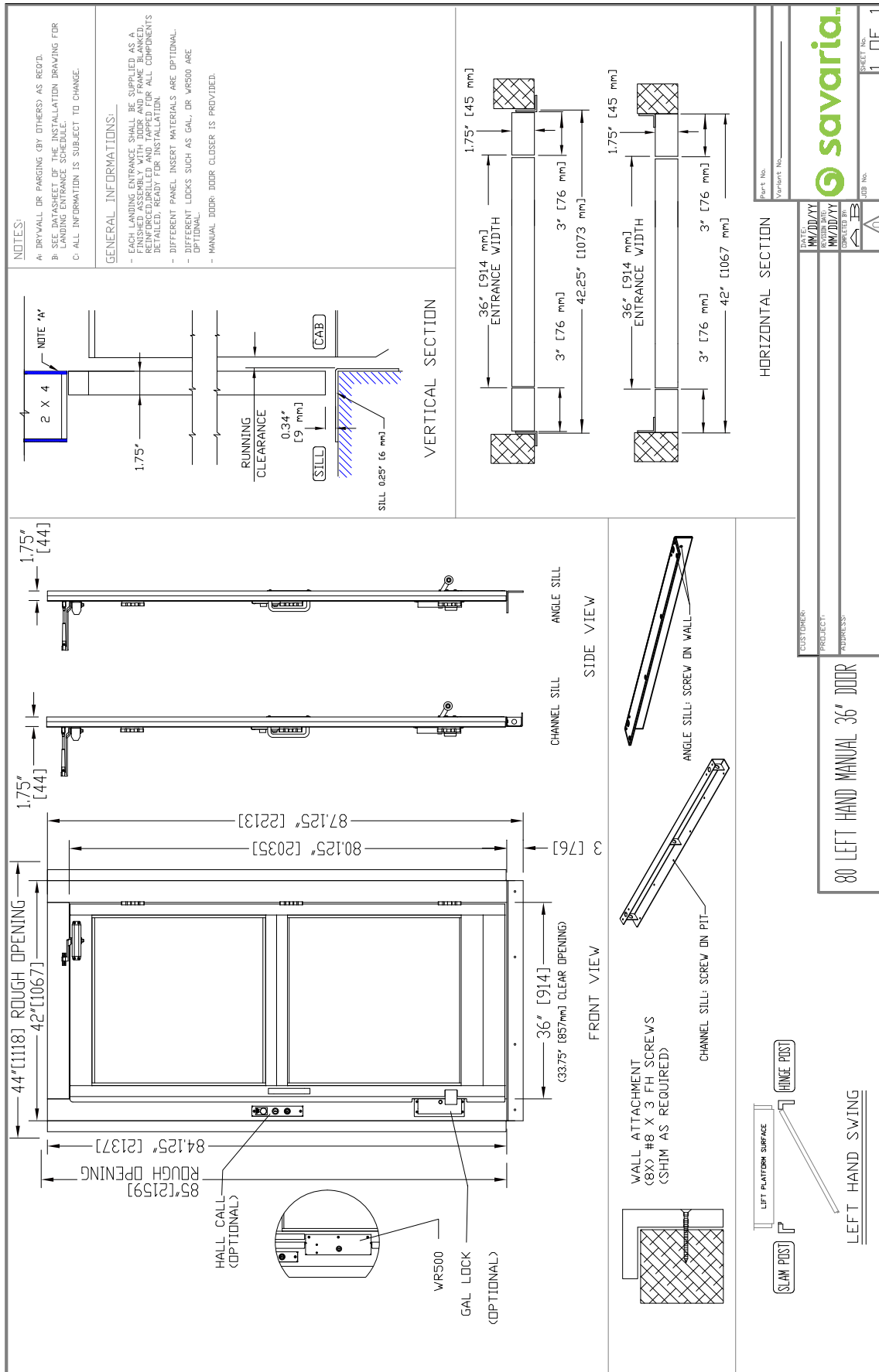

Figure 26: Manual door, right-hand

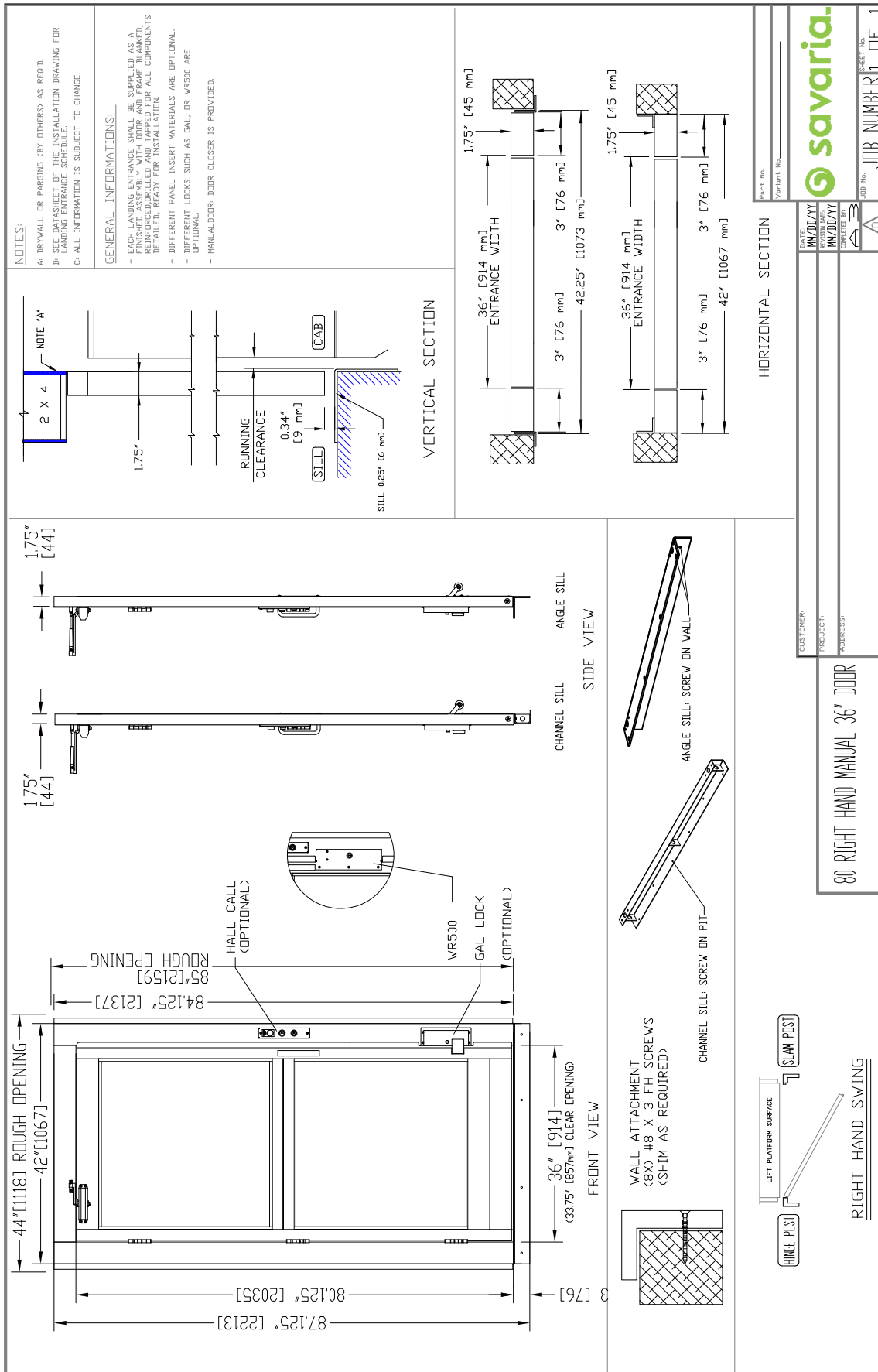

Figure 27: Prodoor auto, left-hand

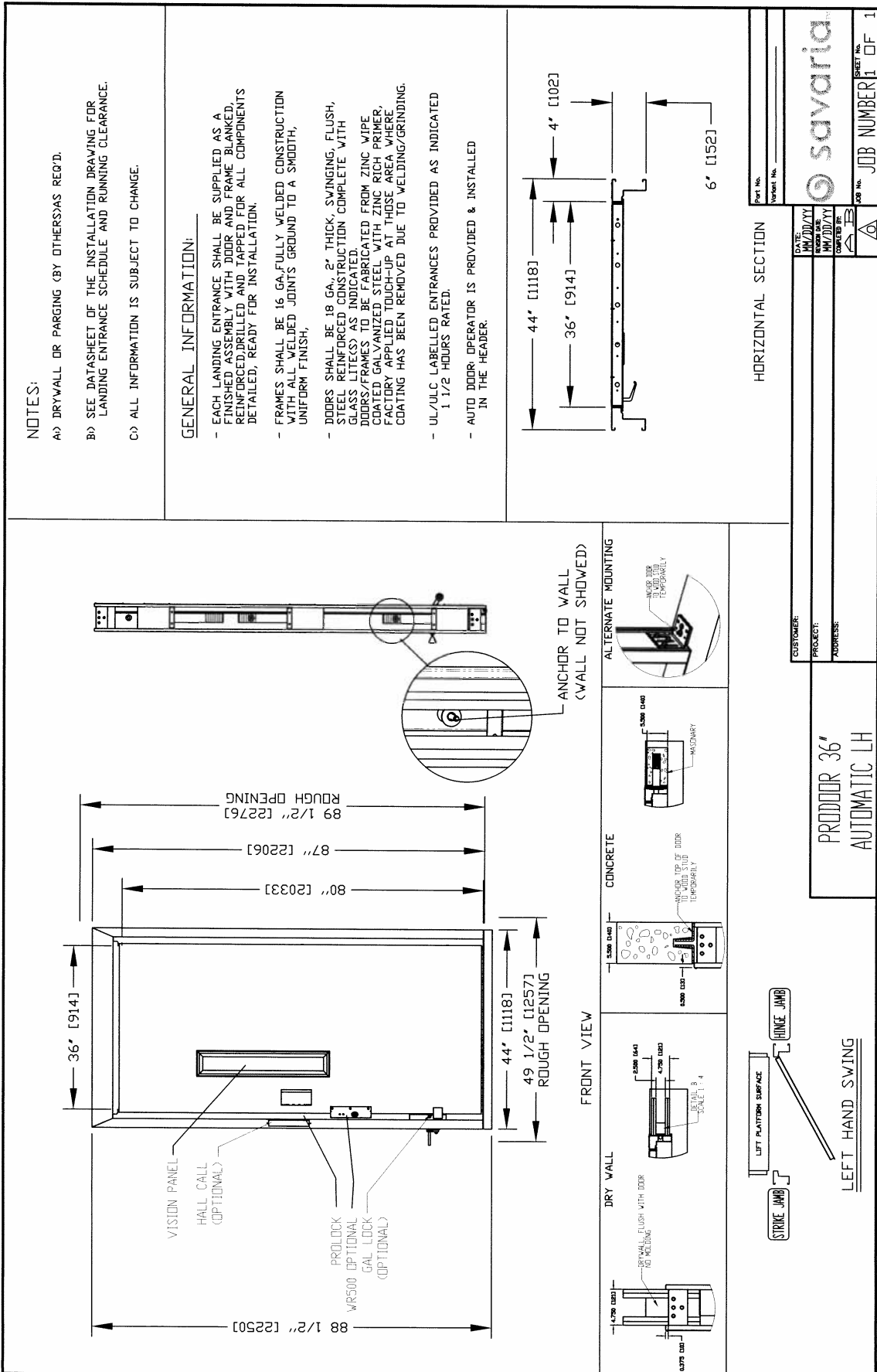

Figure 29: Prodoor manual, left-hand

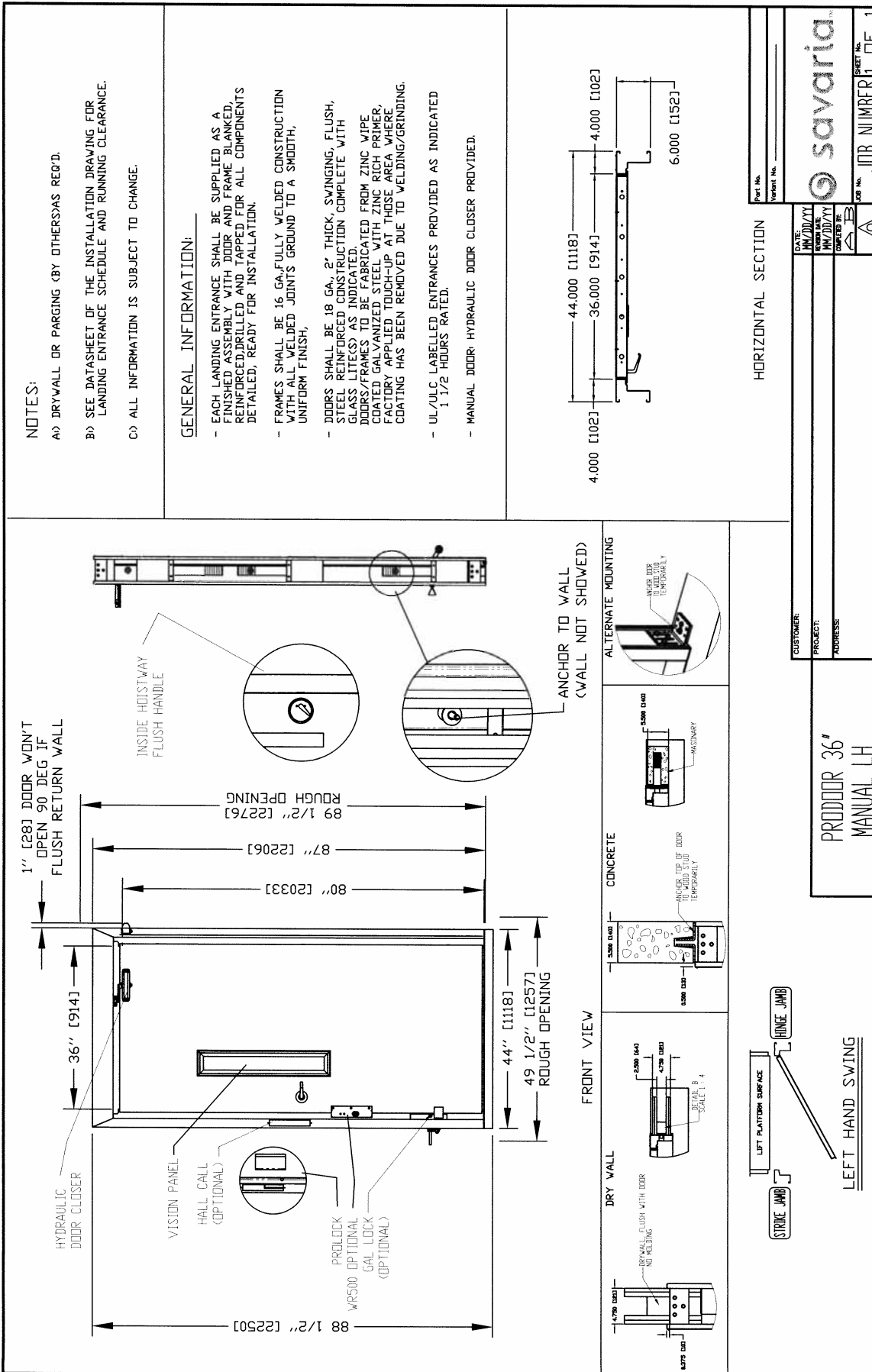

Figure 30: Prodoor manual, right-hand

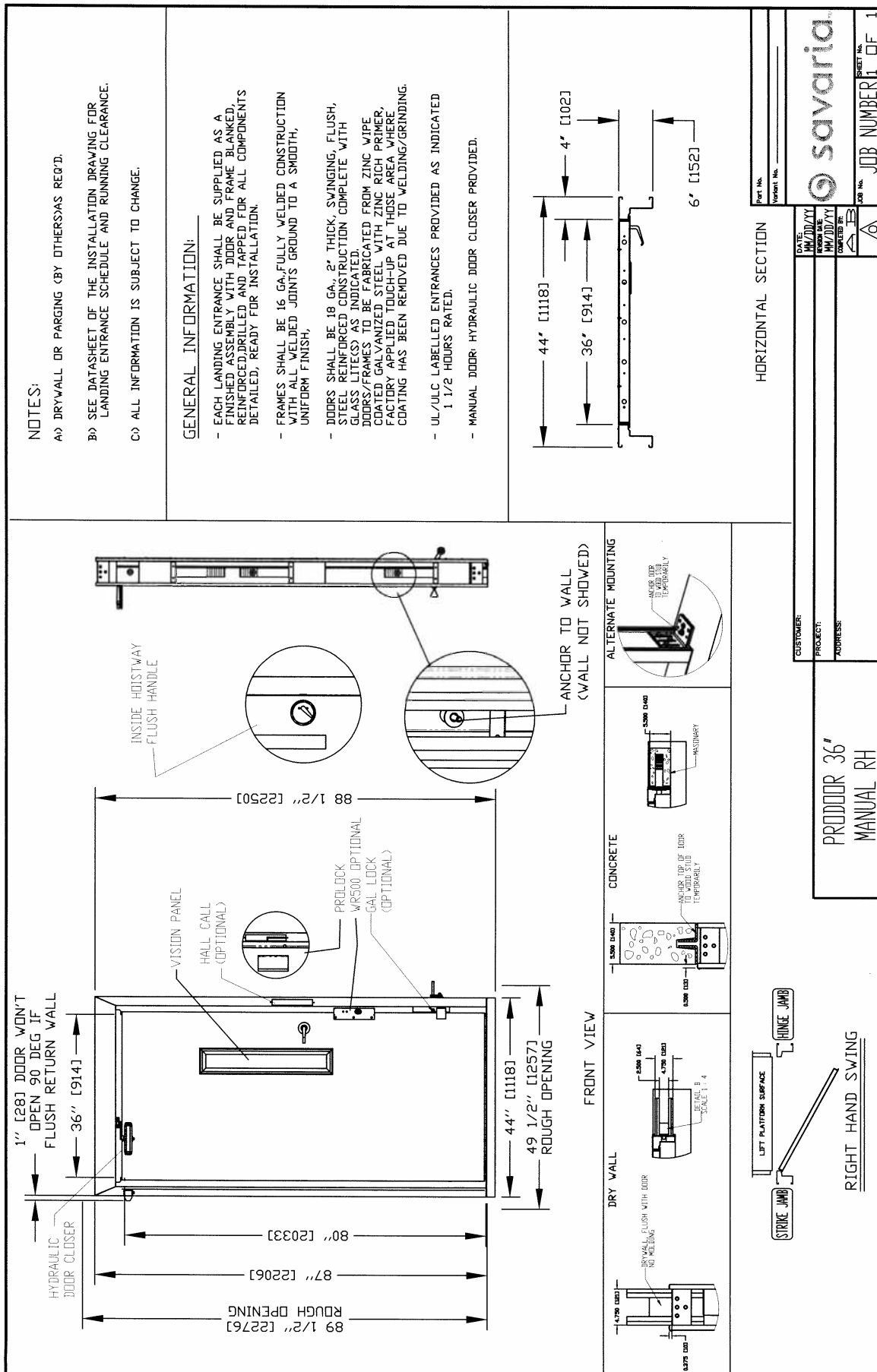

Figure 31: Prodoor installation (drywall)

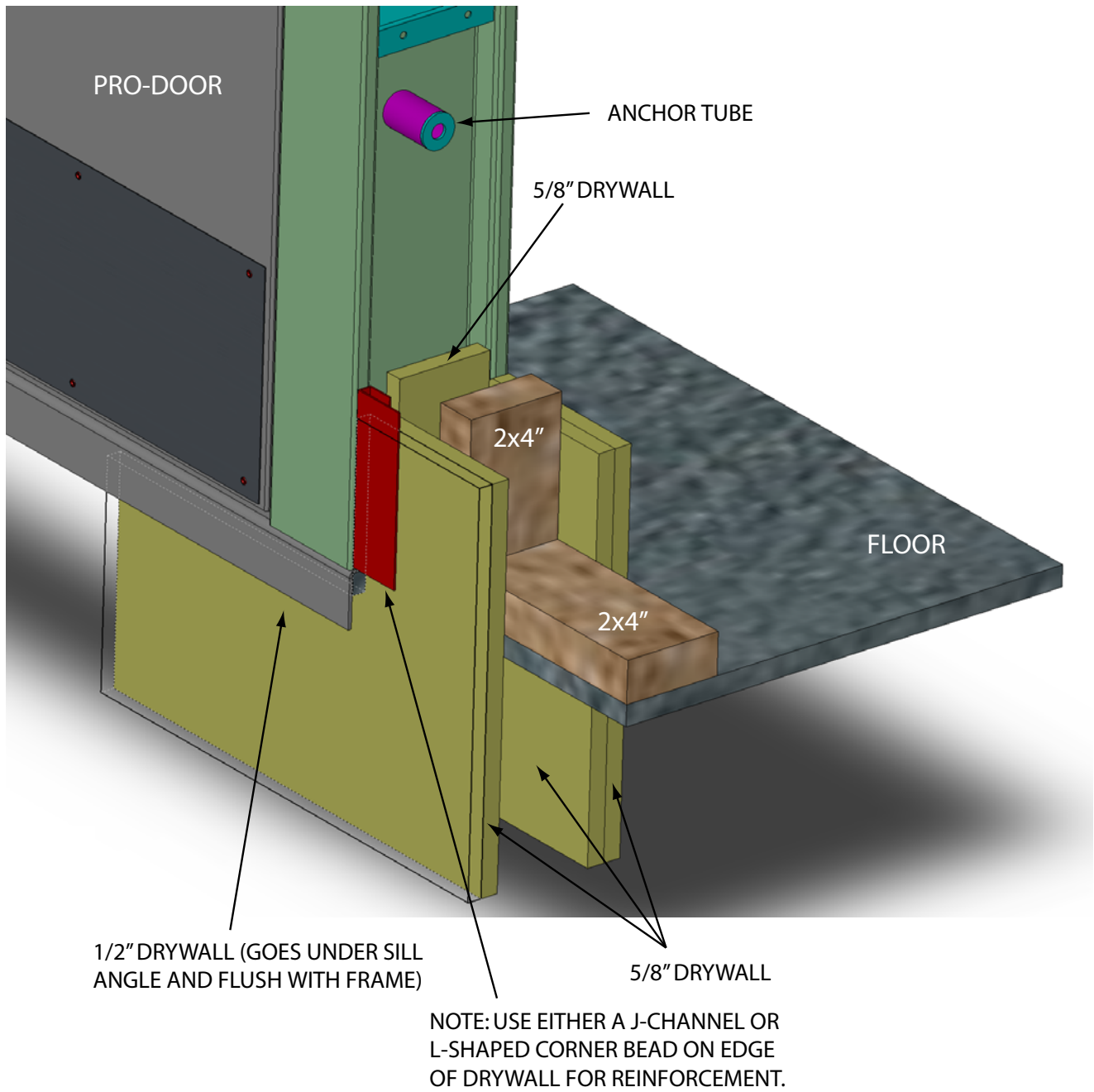

Figure 32: Auto half gate, left-hand

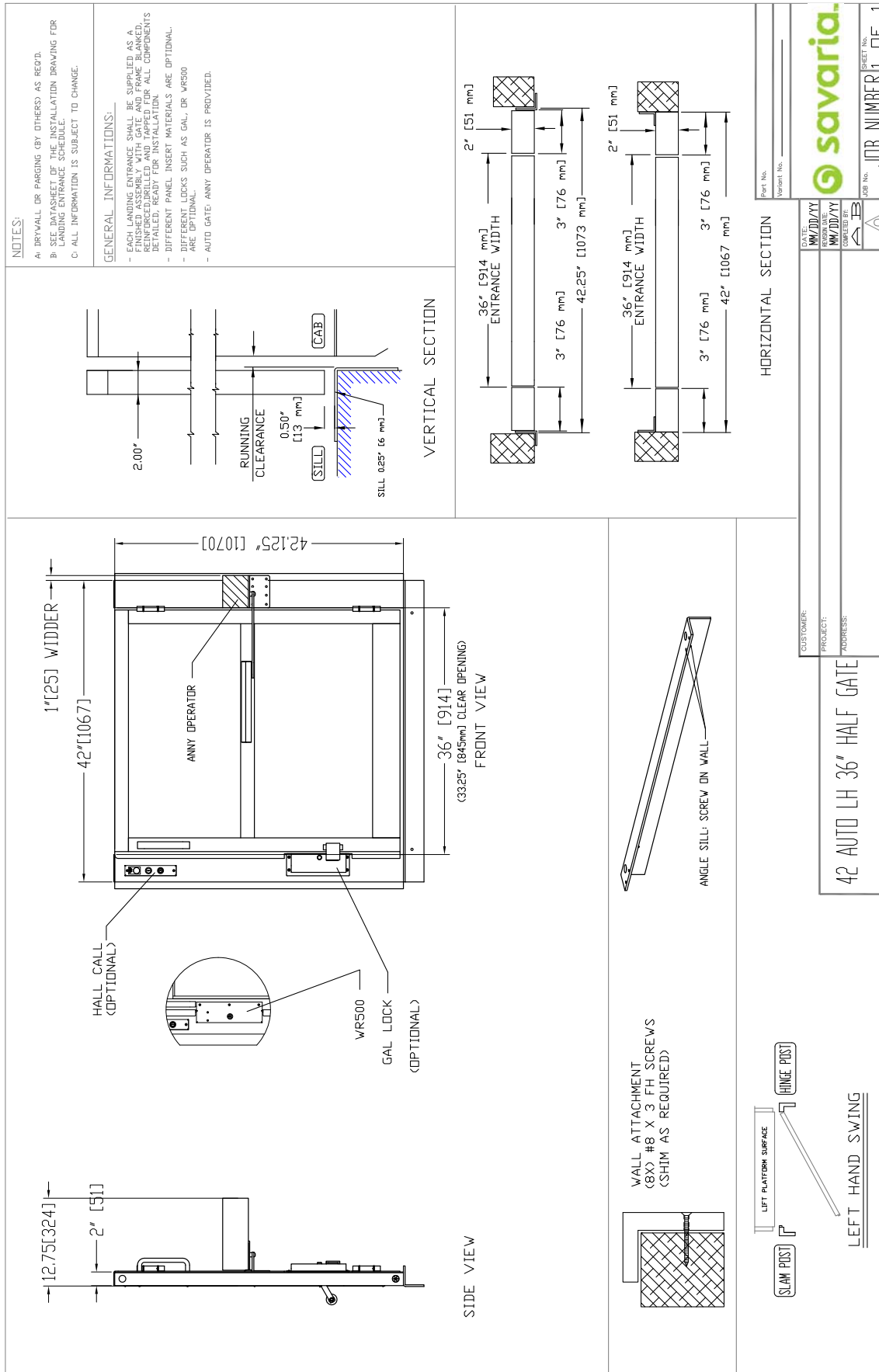

Figure 33: Auto half gate, right-hand

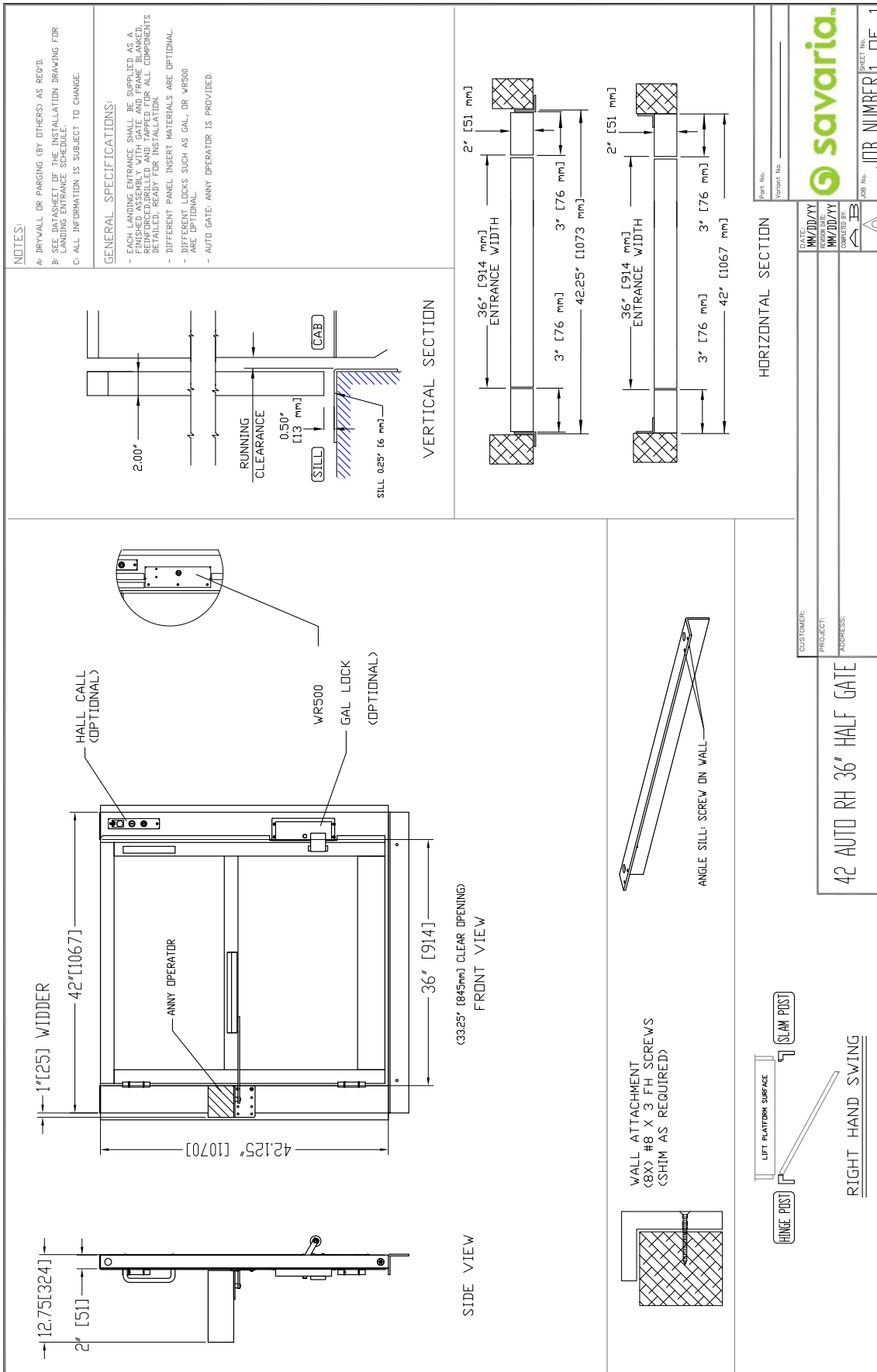

Figure 34: Manual half gate, left-hand

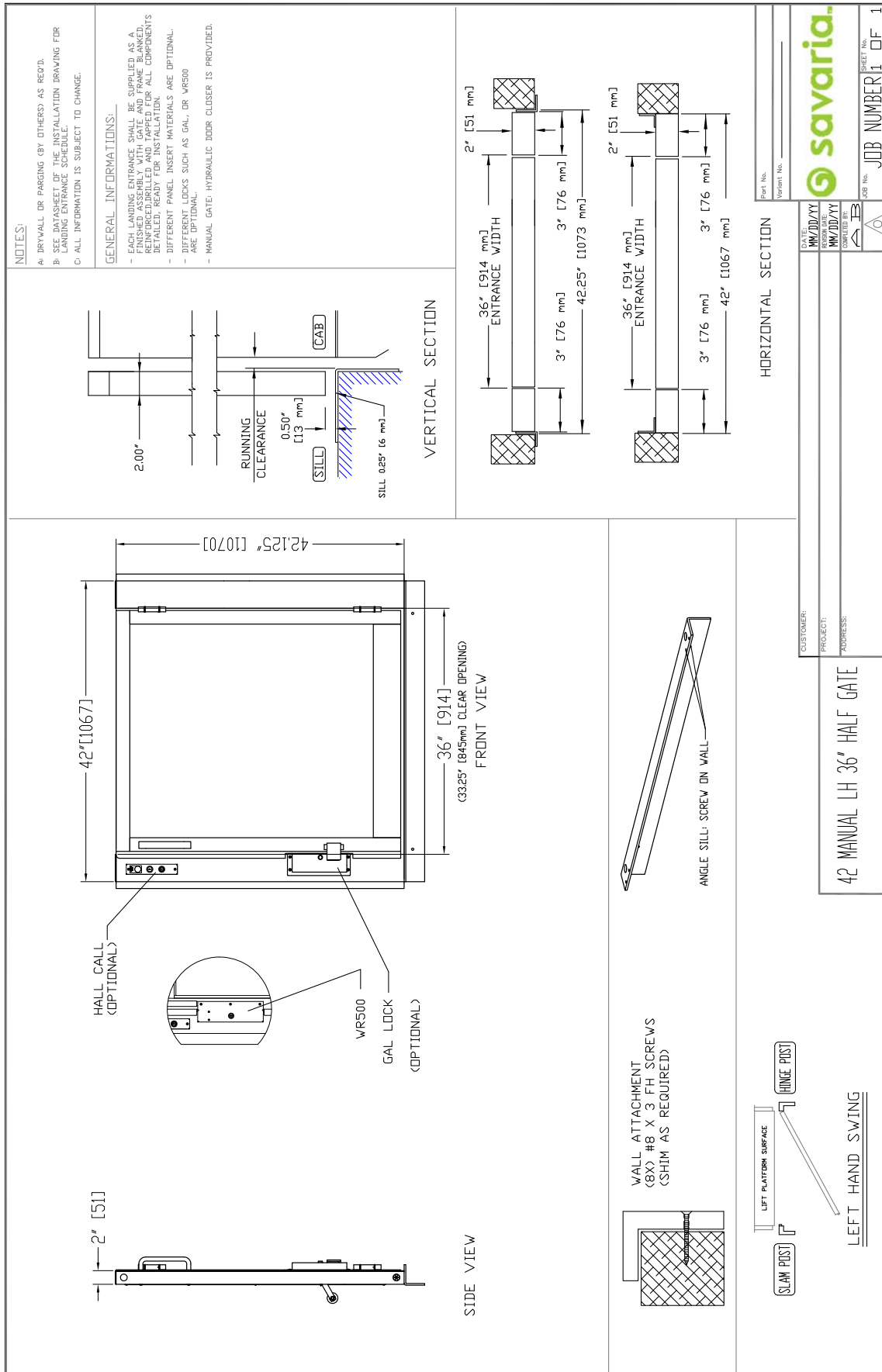

Figure 35: Manual half gate, right-hand

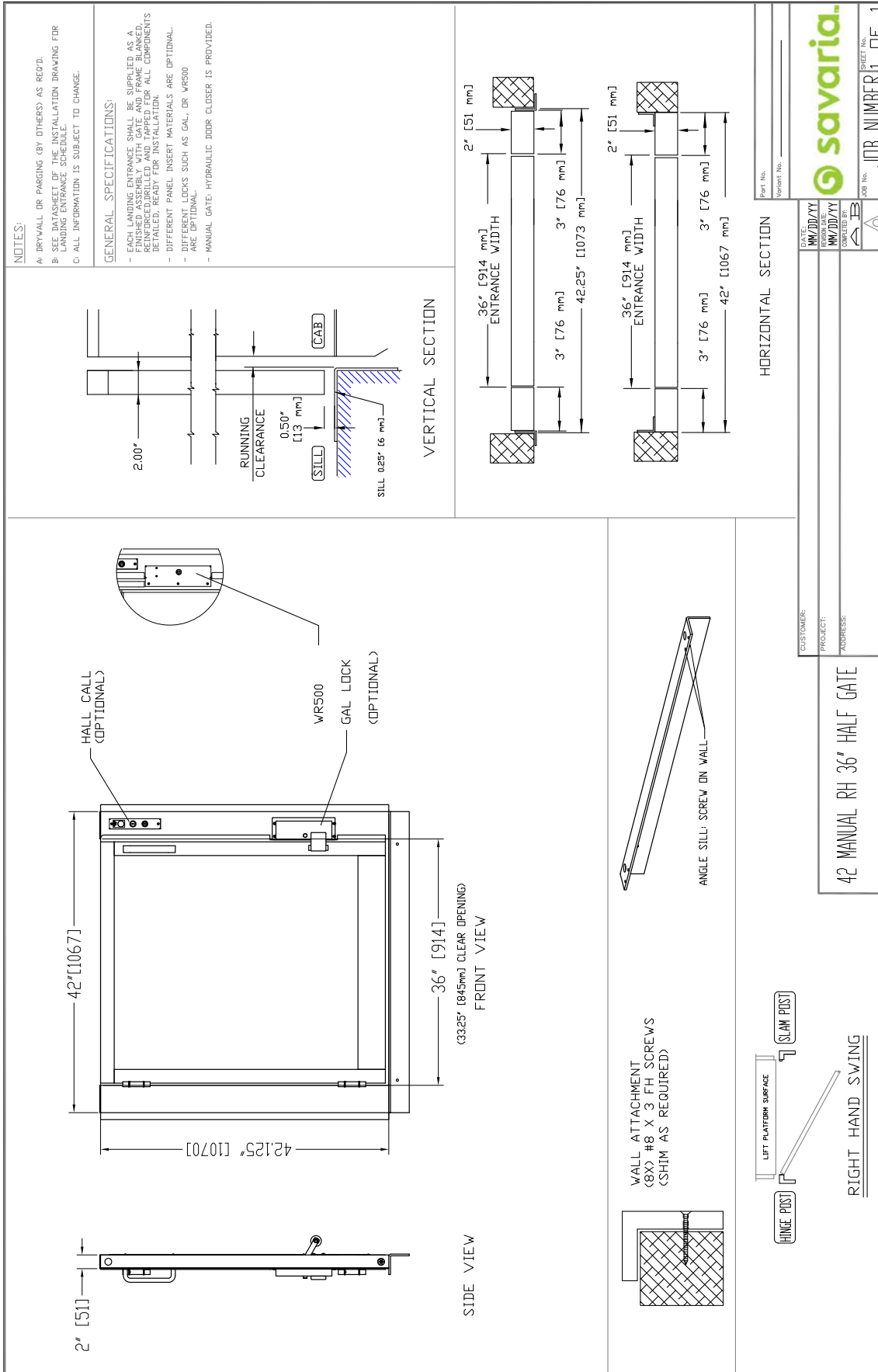

Figure 36: DuraSwing on half gate, right-hand

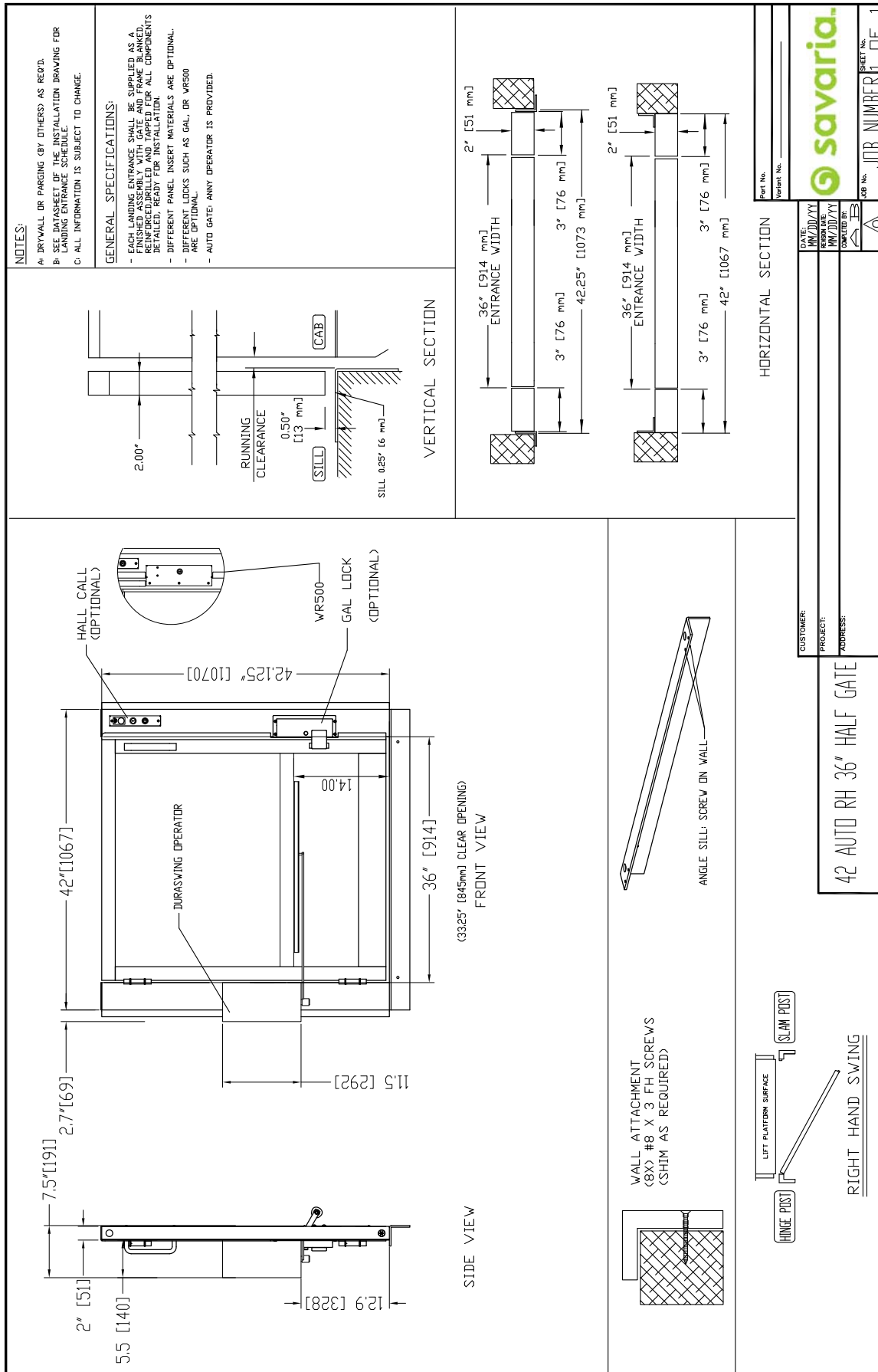

Figure 38: DuraSwing on half gate, left-hand

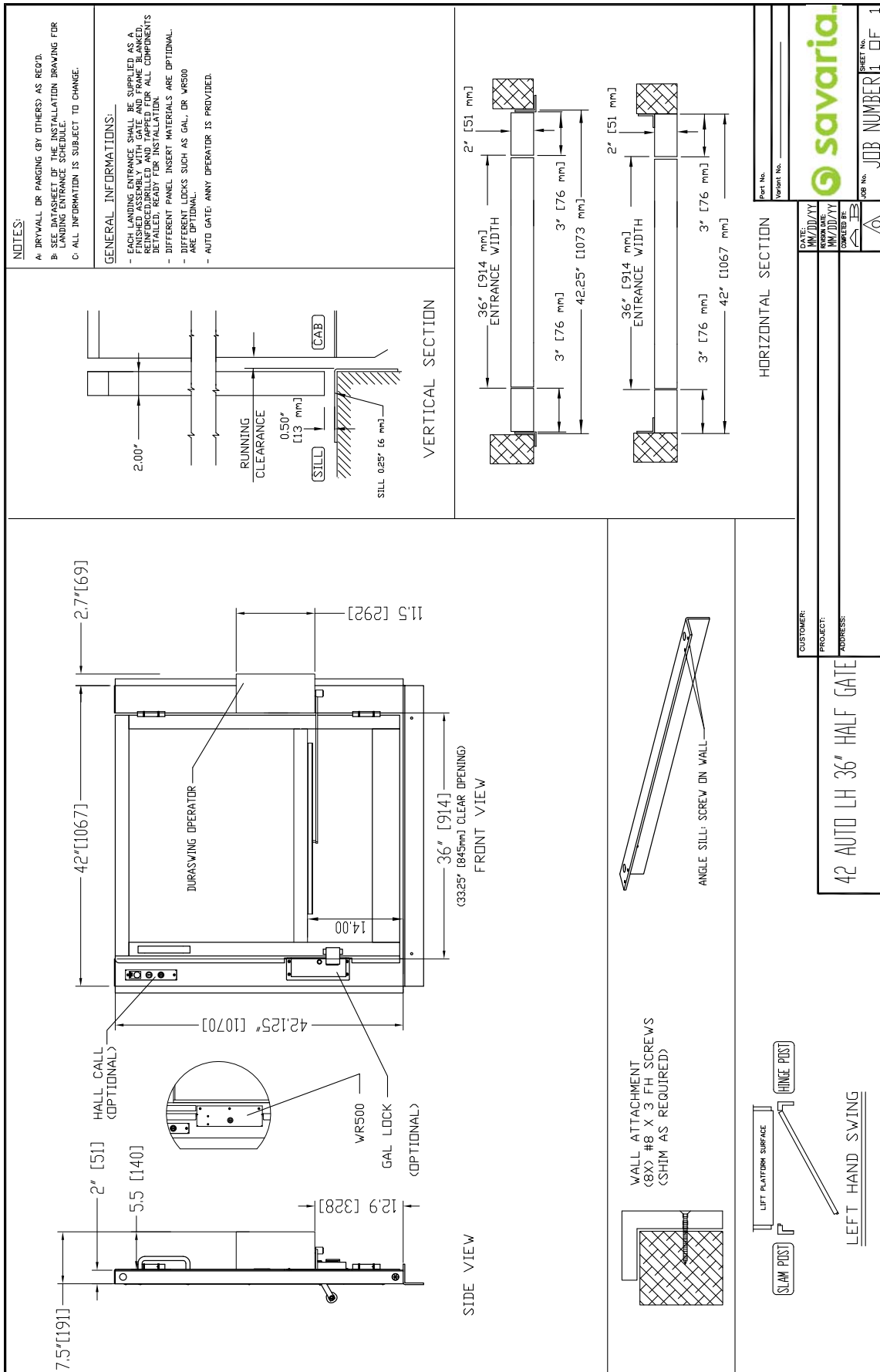

Figure 39: DuraSwing on half gate, left-hand, 45" opening

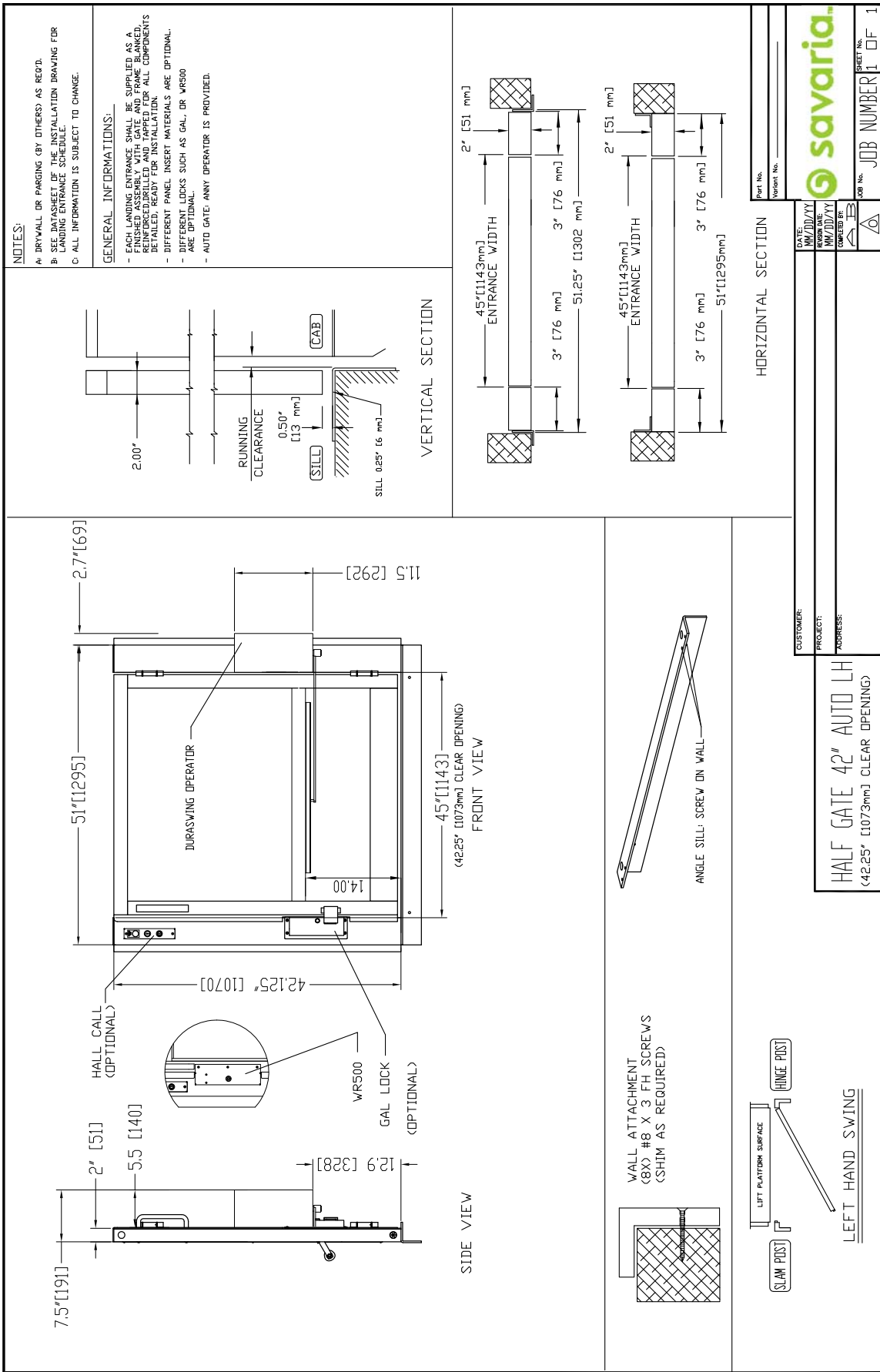
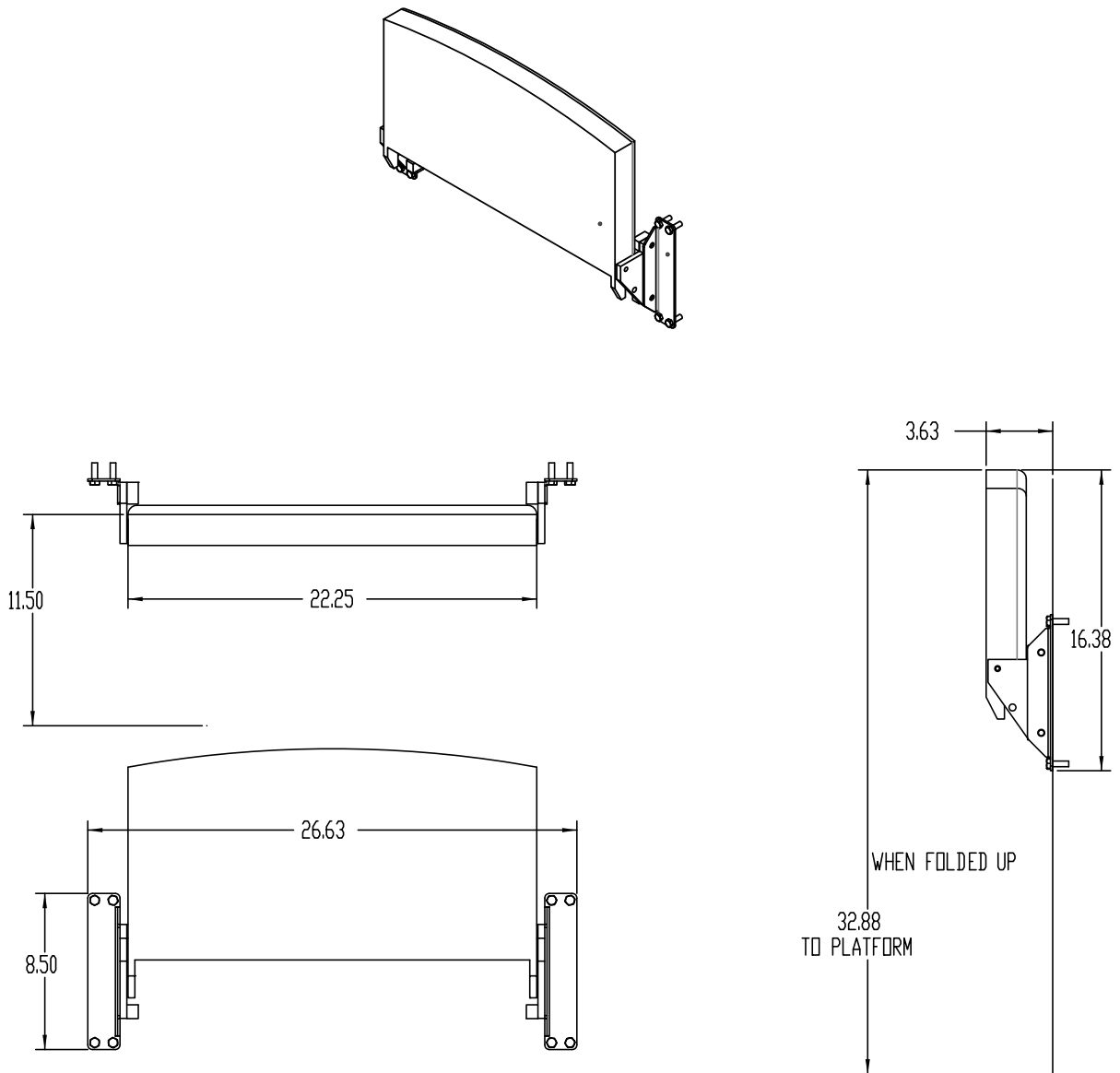
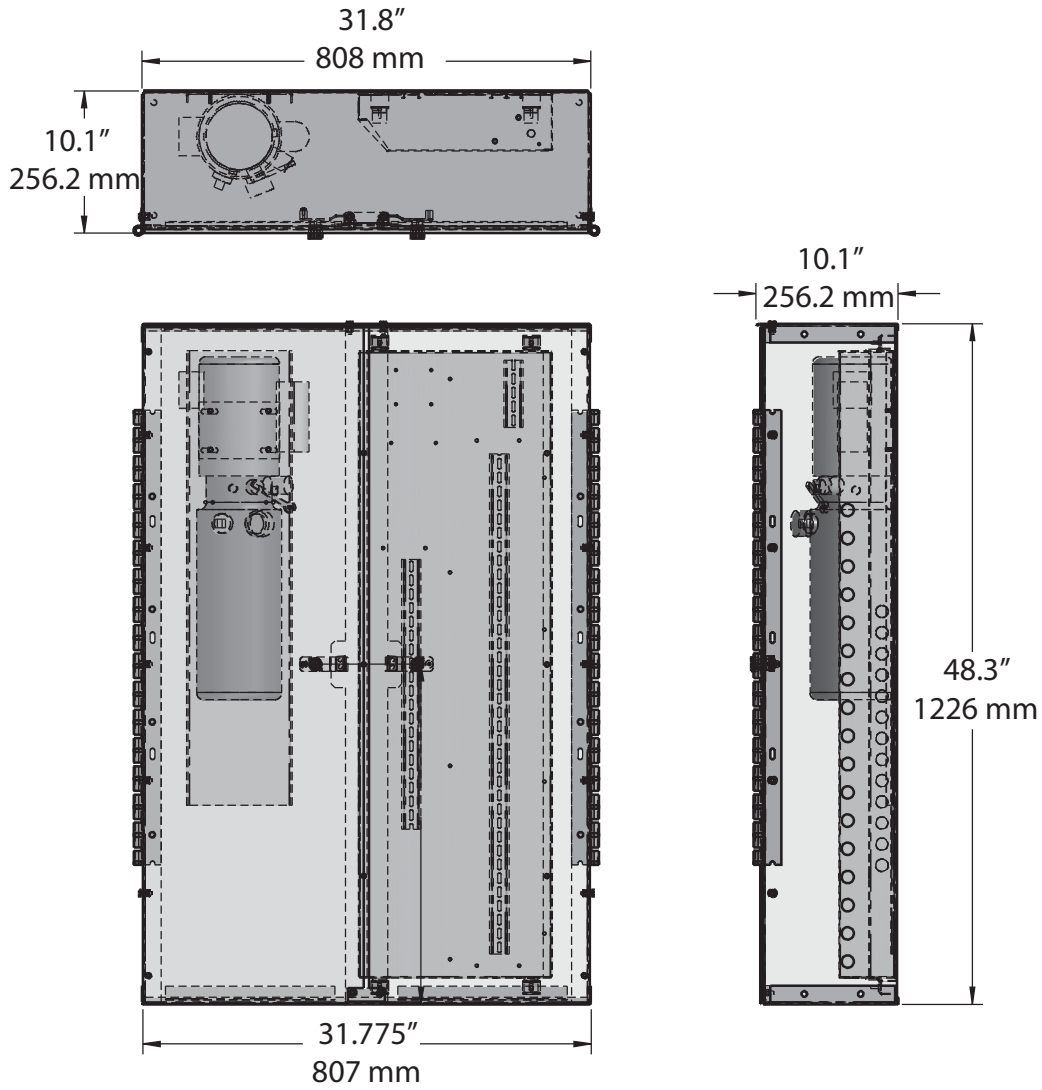

Figure 40: Seat dimensions



NOTE: Maximum seat capacity is 330 lbs (150 kg)

Figure 41: Remote controller/pump box dimensions



PROVISIONS BY OTHERS

GENERAL REQUIREMENTS

Hoistway

The hoistway must be designed and built in accordance with the “safety standard for platform lifts and stairway chairlifts” or the “safety code for elevators and escalators” and all state and local codes.

Plumb Runway

Due to close running clearances, the owner/agent must ensure that the hoistway and the pit (where provided) are level, plumb and square and are in accordance with the dimensions on the installation drawings.

Minimum Overhead Clearance

The owner/agent must ensure the minimum overhead clearance is in compliance with codes.

Construction Site

The owner/agent is required to provide all masonry, carpentry and drywall work as required and shall patch and make good (including finish painting) all areas where walls/floors may need to be cut, drilled or altered in any way to permit the proper installation of the lift.

Dimensions

The contractor/customer is required to verify all dimensions and report any discrepancies to our office immediately.

STRUCTURAL REQUIREMENTS

Floor/Support Wall Loads

The structural engineer is to ensure that the building and shaft will safely support all loads imposed by the lift equipment. Refer to the installation drawings for the loads imposed by the equipment.

Mast to be Securely Fastened

Where required, the mast must be securely fastened to the structural support wall. Refer to the installation drawings for the loads imposed by the equipment.

Where Doors are Required

Suitable lintels must be provided by the owner/agent. Door frames are not designed to support overhead wall loads.

ELECTRICAL REQUIREMENTS

General

Electrical equipment and wiring must comply with Section 38 of CSA C22.1 (Canada) or Section 620 of NEC ANSI NFPA 70 (USA).

Power Supply

A 120 VAC, 20A, 60 Hz, single-phase circuit through a fused disconnect with an auxiliary contact on the main power supply is required.

Lighting

Lighting of 100 lux minimum is required at platforms and landings. Lighting with a switch and electrical GFCI outlet is required in the hoistway pit.

Additional Branch Circuit

Branch circuit with disconnect for door operators, if equipped (120VAC, 15A, 60HZ, 1PH). Branch circuit with disconnect for ventilation system, if equipped (120VAC, 15A, 60HZ, 1PH).

Branch Circuit for Hoistway Pit Lighting and Receptacles (Canada Only)

- a) A separate branch circuit shall supply the hoistway pit lighting and receptacles.
- b) Required lighting shall not be connected to the load side terminals of a ground fault circuit interrupter receptacle(s).
- c) A lighting switch shall be provided and shall be located so as to be readily accessible from the pit access door.
- d) At least one 125V, single-phase, duplex receptacle connected to a 15A branch circuit shall be provided in the hoistway pit.

ENTRANCE REQUIREMENTS**Upper Landing Gates**

Where required, smooth solid barriers are to be supplied and installed on both sides of the entrance at the upper level and must be a minimum of 42" (1067 mm) high. The entrance assembly must be in place prior to this provision.

Fascia Panel Below Upper Level Entrance

Where required, fascia panel must be fastened to a solid wall and be perpendicular to the floor and walls. Hoistway fascia is not self-supporting for long, continuous runs void of entrances. Adequate support for the fascia must be provided.

Entrance Assemblies

Entrance assemblies must be adjusted to align with the platform and interlock equipment. Others must allow an adequate opening.

Return Walls

Return walls at the entrances must be built-in by others after the entrance assemblies are in place. The entrance assembly must be securely fastened to the walls by the contractor.

V1504

Vertical Platform Lift

PLANNING GUIDE

Part No. 000690
Copyright © 2018

Savaria Concord Lifts, Inc.
www.savaria.com

Sales
2 Walker Drive
Brampton, Ontario L6T 5E1
Canada
Tel: (905) 791-5555
Fax: (905) 791-2222
Toll Free: 1-800-661-5112

